

Installation, Operation and Maintenance Manual

IOM

Group: Chiller
Part number: IOM CLIM VS
Date: 13 July 2023

CLIM VS Series Air-Cooled Scroll Compressor Chiller Water Generator Unit

Model

7.5 to 62.5 TR

Refrigerant HFC-410A

50/60 Hz



SAFETY WARNINGS.....4
GENERAL INFORMATION.....5
INSTALLATION AND APPLICATION INFORMATION.....6
REFRIGERATION SCHEMATICS.....13
DIMENSIONS AND WEIGHTS - PACKAGED UNITS.....15
REFRIGERANT CHARGE.....21
ELECTRICAL DATA.....23
UNIT CONTROLLER OPERATION.....34
SEQUENCE OF OPERATION39
UNIT FUNCTIONS43
CIRCUIT FUNCTIONS.....44
ALARMS.....46
CONTROLLER USAGE.....47
VDF COMPRESSOR CONTROLLER.....51
STARTUP AND SHUTDOWN PROCEDURES.....54
UNIT MAINTENANCE.....60
TROUBLESHOOTING CHART.....63

Manufactured in an ISO 9001 certified facility



©2023 Clima Flex . Illustration and data cover the Clima Flex product at the time of publication and we reserve the right to make changes in design and construction at any time without notice.

Pre-Start-Up Checklist - Scroll Compressor Chiller

Must be completed, signed and submitted to Clima Flex at least 2 weeks prior to the requested start date.

Job name				
Place of installation				
Customer order number				
Model number(s)				
G.O. Number(s)				
Chilled water and condensing water for water-cooled chillers	Yes	No	N/A	Initials
Complete piping				
Water strainer(s) installed in piping according to manual requirements				
Water system: flushing, filling and draining; water treatment in place				
Pumps installed and operational (rotation check, filter cleaning)				
Controls in operation (3-way valves, front/bypass gates, by-pass valves, etc.)				
Water system operated and tested; flow rate meets unit design requirements (Not all units include this)				
Flow switch(es)-installed, wired and calibrated				
Ventilation installed on evaporator				
Electrical	Yes	No	N/A	Initials
Building controls in operation				
* Power cables connected to power block or optional disconnect switch				
Power cables have been checked for proper phasing and voltage				
All interlock scripts are complete and meet unit specifications				
Power is applied at least 12 hours prior to start-up				
Oil heaters energized at least 12 hours prior to startup				
Cooler components (EXV sensor transducers) installed and wired properly				
*Wiring complies with National Electrical Code and local codes (See NOTES)				
Various	Yes	No	N/A	Initials
Unit control disconnects everything				
Factory check of remote evaporator/condenser lines				
Leak, evacuation and charge check of all refrigeration piping/components				
Thermometers, wells, gauges, control, etc., installed				
Minimum system load of 80% of available capacity to test/adjust controls				
Attachment: Technical breakdown of selection software				
Attachment: Acknowledgement of Receipt of Final Order				
Attachment: Remote Piping Approval				
<p>NOTES: The most common problems that delay start-up and affect unit reliability are:</p> <p>1. Compressor motor power cables installed in the field are too small. Questions: Contact your local Clima Flex sales representative *. Indicate the size, number and type of conductors and conduits installed:</p> <p>a. From the power supply to the chiller _____</p> <p>* Refer to NFPA 70-2017, article 440.35.</p> <p>2. Remote evaporator piping is incomplete or incorrect. Provide approved piping diagrams.</p> <p>3. The items on this list have been incorrectly recognized, resulting in delayed start-up and possible additional round-trip travel costs</p>				

Contractors' representative

Signature _____
 Name _____
 Company _____
 Date _____
 Phone / Mail _____

Clima Flex Sales Representative

Signature _____
 Name _____
 Company _____
 Date _____
 Phone / Mail _____

This manual contains safety instructions that must be followed during installation and maintenance of the unit. Read this manual before installing or operating this unit.

NOTES: Installation and maintenance should be performed only by qualified personnel who are familiar with local codes and regulations and who have experience with this type of equipment.

⚠ DANGER ⚠

LOCK OUT/LABEL all power sources before starting, pressurizing, depressurizing or shutting down the chiller.
Disconnect electrical power before servicing equipment. More than one disconnection may be required to deenergize the unit. Failure to follow this warning to the letter can result in serious injury or death. Be sure to read and understand the installation, operating and service instructions in this manual.

⚠ WARNING ⚠

Electric shock danger. Improper handling of this equipment can cause personal injury or equipment damage. This equipment must be properly grounded. Control panel connections and maintenance should be performed only by personnel knowledgeable in the operation of the equipment being controlled. Disconnect electrical power before servicing equipment.

⚠ CAUTION ⚠

Static sensitive components. Static discharge during handling of the electronic circuit board can cause damage to components. Use a static strap before performing any service work. Never unplug any cables, circuit board terminal blocks, or power plugs while power is applied to the panel.

⚠ CAUTION ⚠

When moving refrigerant to/from the cooler using an auxiliary tank, a grounding strap should be used. An electrical charge builds up when halo-carbon refrigerant travels in a rubber hose. A grounding strap should be used between the auxiliary refrigerant tank and the cooler end sheet (ground to ground), which will safely carry the charge to ground. Failure to follow this procedure may result in damage to sensitive electronic components.

⚠ WARNING ⚠

If refrigerant leaks from the unit, there is a potential choking danger as the refrigerant will displace air in the immediate area. Be sure to follow all applicable published industry-related standards and local, state, and federal statutes, regulations, and codes if refrigerant is produced. Avoid exposing refrigerant to an open flame or other ignition source.

⚠ WARNING ⚠

Polyolester oil, commonly referred to as POE oil, is a synthetic oil used in many refrigeration systems and may be present in this Clima Flex product. POE oil, if it ever comes in contact with PCV/CPVC, will coat the inside wall of the PVC/CPVC pipe and cause environmental stress fractures. Although there is no PCV/CPCV pipe in this product, keep this in mind when selecting piping materials for your application, as system failure and property damage could occur. Consult the pipe manufacturer's recommendations to determine appropriate pipe applications.

DANGER IDENTIFICATION INFORMATION

⚠ DANGER ⚠

Danger indicates a dangerous situation which, if not avoided, will result in death or serious injury.

⚠ WARNING ⚠

Warning indicates a potentially dangerous situation which may result in property damage, personal injury or death if not avoided

⚠ CAUTION ⚠

Caution indicates a potentially dangerous situation which may result in minor injury or equipment damage if not avoided.

Notes: Indicate important details or clarifying statements for the information presented.

GENERAL INFORMATION

Clima Flex 's CLIM VS series air-cooled chilled water generators are complete, self-contained, automatic chillers designed for outdoor installation. The package units are fully assembled, factory wired, charged and tested.

The electrical control center includes all operating controls and equipment protection necessary for reliable automatic operation. Components housed in a weatherproof control panel.

NOMENCLATURE

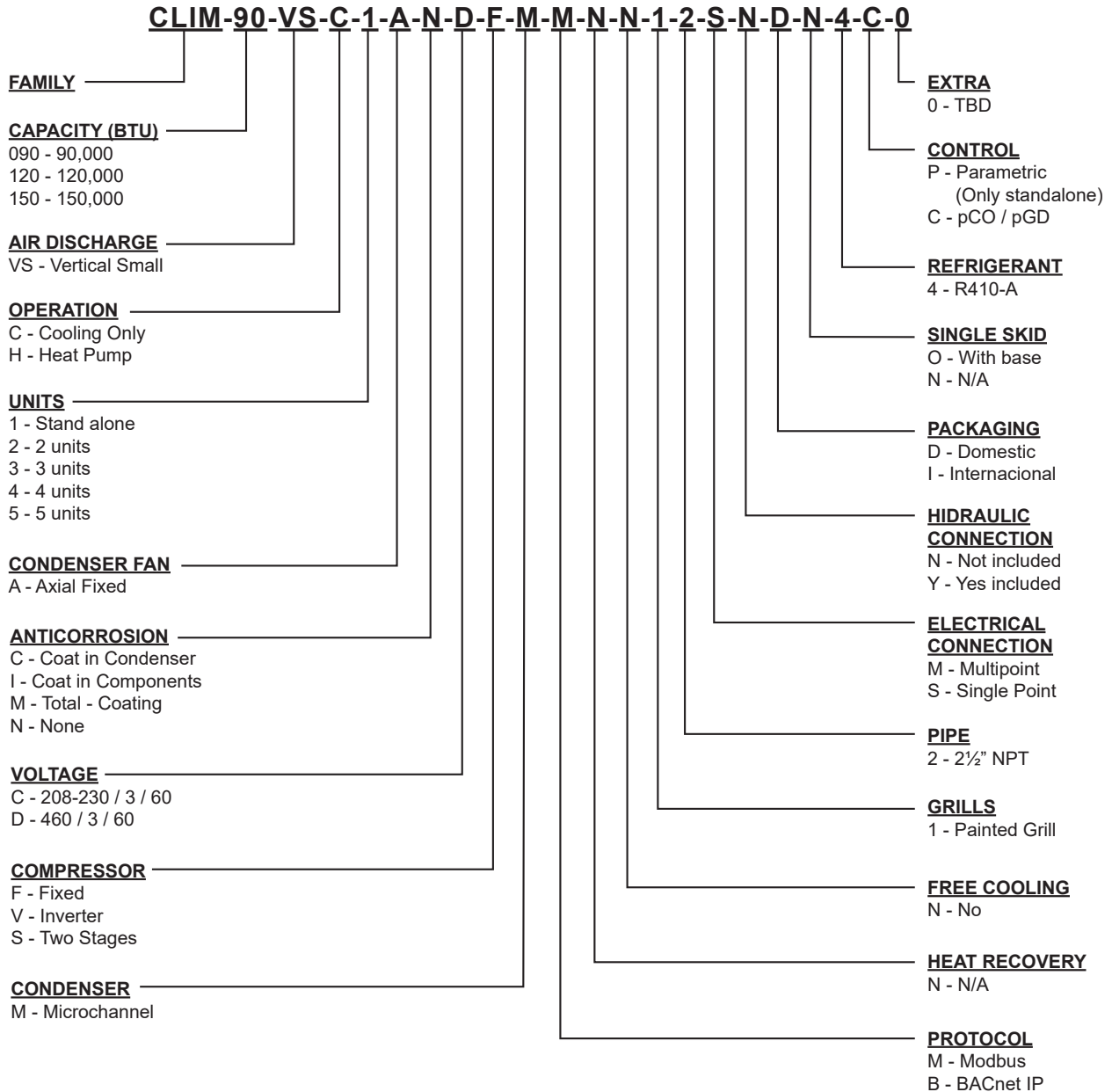

Table 1. Operating and Standby Limits

Maximum standby ambient temperature	130°F (54°C)
Maximum operating ambient temperature	105°F (41°C)
Minimum operating ambient temperature (standard control)	32°F(0°)
Cold water outlet temperature	40°F A 65°F (4°C to 18°C)
Outgoing chilled fluid temperatures (with antifreeze) - Note that in cases of high ambient temperature, the lowest outgoing water temperature settings may be outside the chiller operating envelope.	15°F A 65°F (-9°C to 18°C)
Maximum evaporator inlet fluid temperature	81°F (27°C)
Maximum temperature of inlet fluid to non-operating evaporator	100°F (38°C)

NAMEPLATES

The unit nameplate is located on the outside of the unit power panel. Both the model number and serial number are located on the unit nameplates; the serial number is unique to the unit.

These numbers should be used to identify the unit in case of service, parts or warranty questions. This nameplate also contains the unit's refrigerant charge and electrical ratings. The evaporator nameplate is under the insulation and contains the serial number. The compressor nameplate is located on each compressor and provides pertinent electrical information.

⚠ WARNING ⚠

Installation should be performed by qualified personnel who are familiar with local codes and regulations.

INSPECTION

Check all items carefully against the bill of lading.

Inspect all units for damage upon arrival. Report shipping damage and file a claim with the carrier.

Check the nameplate on the unit before unloading, making sure it matches the available power supply.

Clima Flex is not responsible for physical damage that occurs after the unit leaves the factory.

HANDLING

Take care to avoid rough handling of the unit. Do not push or pull the unit from other than the base while seated on properly sized dollies.

To lift the unit, 2-1/2 (64 mm) diameter lifting eyes are provided at the base of the unit. Arrange the spreader bars and cables to prevent damage to the condenser coils or cabinet (see Figure 1).

⚠ CAUTION ⚠

All lifting locations must be used to avoid damage to the unit.

⚠ DANGER ⚠

Improper rigging, lifting or moving of a unit can result in property damage, serious personal injury or death. Follow the rigging and moving instructions carefully. Do not stand under the unit while it is being lifted or installed.

Figure 1. Required elevation arrangement.

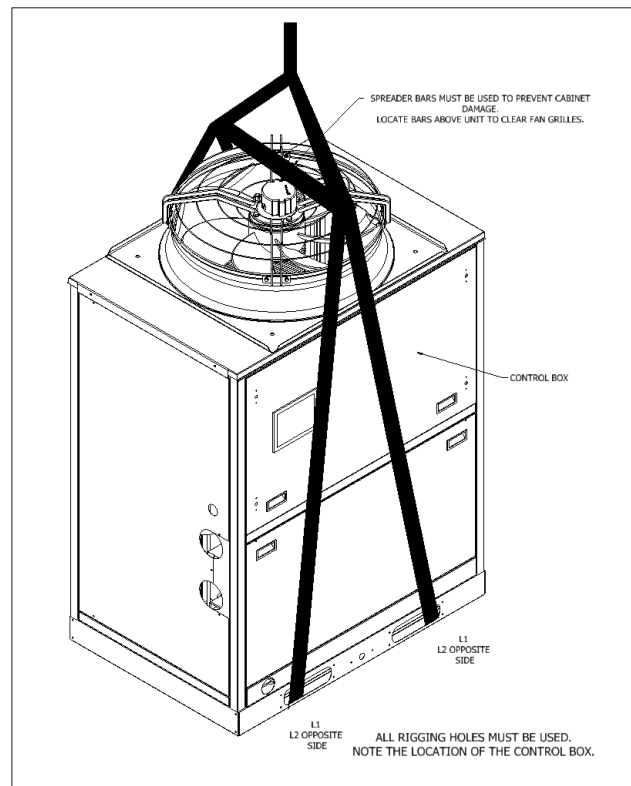

PLACEMENT OF THE UNIT

The units must be installed in accordance with all national and local safety standards. If there are no applicable local standards, the installation must be carried out in accordance with national standards.

INSTALLATION AND APPLICATION INFORMATION

Clima Flex units are designed for outdoor installation. It is necessary for the units to have air ventilation, in addition to a free air inlet (see figure 2) to allow proper air circulation, as well as to provide access for servicing the equipment.

For optimal operation of the equipment, a correct connection to the hydraulic network and the minimum water flow per minute specified in the technical information sheet of the equipment is required. As well as a correct connection to the electrical power according to the electrical values of the technical information sheet of the system.

Figure 2. Recommended spaces for the unit.

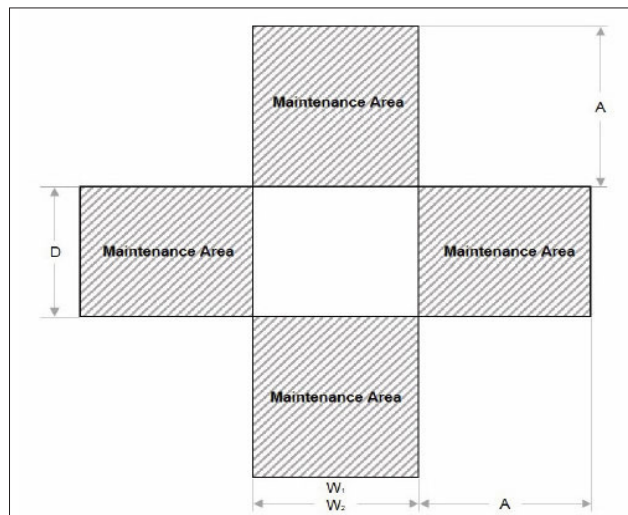

MODELS		DIMENSIONS					
		A		D			
		in	cm	in	cm	in	cm
CLIM VS 7.5 TR	w1	30½"	77.74	39½"	100	31¼"	90.65
CLIM VS 10 TR	w2	38	96.52	39½"	100	31¼"	90.65
CLIM VS 12.5 TR	w3	46¼"	118.70	39½"	100	31¼"	90.65

The units should be installed on a solid and well-balanced base. In case it is placed on the floor, a solid concrete base should be fabricated, which slightly exceeds the area of the unit.

This base must be able to support the weight of the unit. Anti-vibration supports must be installed between the frame of the unit and the concrete base of the steel beams; for such installation, use the dimensioning diagram attached in the installation manual included with your equipment.

The unit frame must be perfectly level during installation, if necessary insert shims under the anti-vibration mounts.

If the unit will be installed in places of easy access for people and/or animals, it is recommended to place a protection grid to prevent access.

To ensure optimum performance of the unit once in place, some instructions and precautions should be followed such as:

- Ensure a strong and solid base to reduce noise and vibration.
- Avoid installing the unit in areas that may be hazardous during equipment maintenance, such as platforms without guardrails, guide rails, or areas that do not meet the space requirements around the unit.

- The installer is responsible for calculating the best position for the unit. It is vitally important that the suggested clearances are respected in order to provide adequate ventilation for the condenser louvers.
- Avoid recirculation of hot air.
- Avoid lack of air supply to the air-cooled condenser. Failure to comply with these conditions can result in increased condenser pressure which in turn can lead to poor energy efficiency and cooling capacity.

MOUNTING

The inside of the base rail is open to allow access for securing mounting bolts, etc.

All compressor bolts, rubber, grommets and fasteners should be left in place in the base. None of these fasteners are considered "temporary shipping bolts".

CLEANING SERVICE

- The control panels are located at the end of the chiller and require a minimum clearance of 1.2 meters in front of the panels. The compressor, filter-driers and line shutoff valves are accessible on each side or end of the unit. Do not block access to the sides or ends of the unit with piping or ductwork.
- These areas must be open for service access. The minimum service distance is as follows:

A. Sides

- 4 fan models: Minimum of 1.2 m (4 ft.)
- 6 to 14 fan models: It is strongly recommended that a minimum of 8 ft (2.4 m) be left on one side to allow for coil replacement. Coils may be removed from the top, leaving a minimum of 4 ft (1.2 m) side clearance; however, unit performance may be diminished.

B. Control panel end

- All models: Minimum of 4 feet (1.2 meters).

C. Opposite end of control panel

- 4-fan models: Minimum 8 feet (2.4 m) to remove coil.
- 6- to 14-fan models: 8 ft (2.4 m) minimum. Clearance may be reduced to 4 ft (1.2 m) if side clearance is sufficient for evaporator service and removal.

Figure 3. Cleaning service

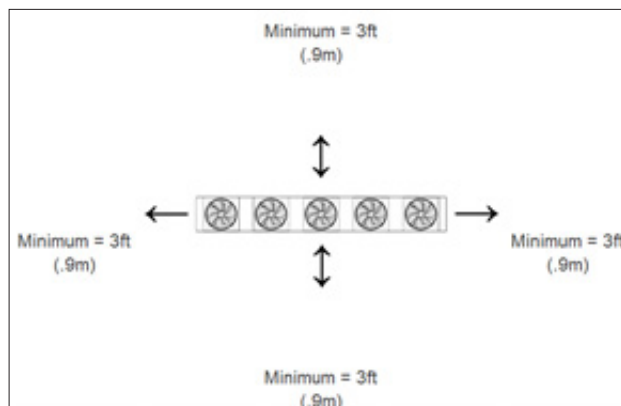

ON-SITE PREREQUISITE

For optimal operation of the equipment, a correct connection to the hydraulic network and the minimum water flow per minute specified in the technical information sheet of the equipment is required. As well as a correct connection to the electrical power according to the electrical values of the technical information sheet of the system.

OPERATING SPACE REQUIREMENTS

AIR operating equipment is designed to be installed OUTDOOR. It is necessary for the equipment to have adequate ventilation, as well as a free air inlet to allow proper air circulation, and to provide access and space for equipment maintenance.

Sufficient distance must be maintained between the unit and adjacent walls or other units to allow the required airflow from the unit to reach the coils. Failure to do so will reduce capacity and increase energy consumption.

The clearance requirements shown are a general guide and cannot take into account all scenarios. Factors such as prevailing winds, additional equipment within the space, outside air temperature and many other factors may require more clearance than shown. Additional clearances may be required under certain circumstances.

The graphs on the following pages indicate the minimum clearance for different types of installations and also the reduction in capacity and increase in power if a smaller space is used. The graphs are based on individual cases and should not be combined with other scenarios.

⚠ CAUTION ⚠

The performance of the unit may be affected if the operating clearance is not sufficient.

Case 1. Building or wall on one side of the unit

NOTES: Assumes a solid height wall higher than the unit. Refer to case 4 for partial wall openings.

For Tandem 7.5 TR models, maintain a minimum of 4 feet from a wall of any height.

For Tandem 10 TR models, maintain a minimum of 6 feet from a wall of any height.

For Tandem 12.5 TR models, maintain a minimum of 8 feet from a wall of any height.

Figure 4. Building or wall on one side of the unit

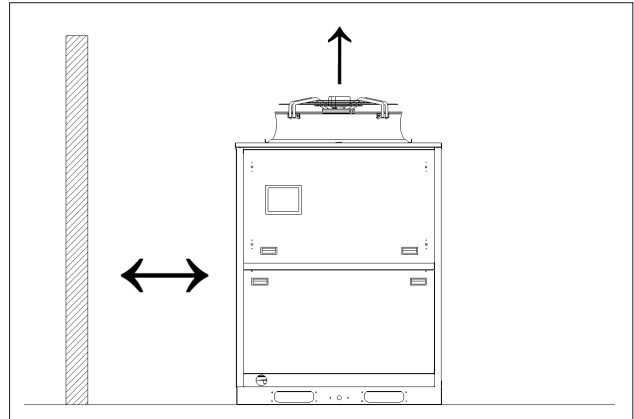

Case 2. Two units side by side

For models 05-20, there should be a minimum of 4 feet between two units placed side by side; however, performance may be affected at this distance. For models 30-62.5, the minimum is 6 feet, since closing the gap may cause recirculation of air and elevation of condenser pressure. Assuming the requirement that one side have at least 8 feet of service clearance is met, the figures in Case 2 show the performance adjustments as the distance between two units increases.

Figure 5. Two units side by side

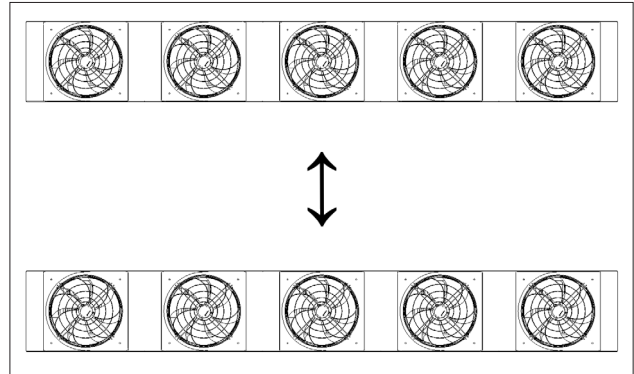

Case 3. Three or more units, side by side

For all models, there must be a minimum distance between units placed side by side; however, performance may be affected at this distance. The minimum distances are: models 5 to 10 TR - 4 feet, models 12.5 to 30 - 5 feet, models 40 to 62.5 - 6 feet.

INSTALLATION AND APPLICATION INFORMATION

Figure 6. Three or more units, side by side

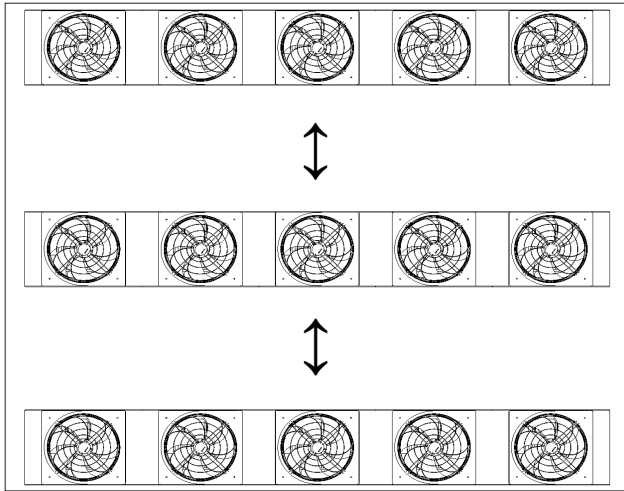

Case 4. Open protection walls

Decorative walls are often used to help conceal a unit, either on the ground or on the roof. Whenever possible, design these walls so that the combination of their open area and distance to the unit does not require a performance adjustment.

If the percentage of wall openness is less than recommended for the distance to the unit, it should be considered a solid wall. The wall height is assumed to be equal to or less than the height of the unit when mounted on its base bracket.

If the wall height is greater than the unit height, refer to Case 5: Pit Installation for performance adjustment factors. The distance from the sides of the unit to the side walls must be sufficient for service, such as opening the control panel doors.

In the case of uneven wall separation, the distance from the unit to each wall can be averaged as long as no distance is less than 4 feet. Values are based on walls on all four sides.

Case 5. Pit installation

Pit installations can cause operating problems due to recirculation and air restriction and require that sufficient air separation be provided, safety requirements be met, and service access be provided. A solid wall surrounding a unit is substantially a pit and this datum should be used. Sometimes a steel grating is used to cover a pit to prevent accidental falls or trips into the pit.

The grille material and installation design should be strong enough to prevent such accidents, but should provide plenty of open area to avoid recirculation problems.

Have the Clima Flex sales representative review the installation of any pit prior to installation to ensure that it has sufficient airflow characteristics and is approved by the facility design engineer to avoid the risk of an accident.

Figure 7. Pit installation

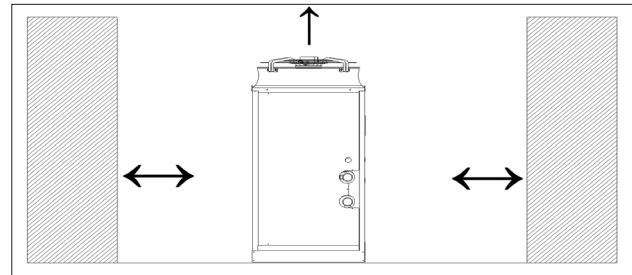

⚠ CAUTION ⚠

To prevent damage to the evaporator and possible failure of the chiller, a supply filter is required in the inlet water piping that connects to this evaporator. This filter must be installed prior to operation of the chilled liquid pumps.

COLD WATER PIPES

Field-installed water piping for the chiller should include:

- A cleanable filter installed at the water inlet to the evaporator to remove debris and impurities before they reach the evaporator. Install the cleanable filter within 1,500 mm tubing length from the evaporator inlet connection and downstream of any solder connections (no solder connections between the filter and evaporator). CLIM VS models 7.5 - 62.5 require a filter with perforations no larger than 1.6 mm (0.063") in diameter. For more information, refer to the inlet strainer guidelines on page 10-11.
- A water flow switch should be installed in the horizontal piping of the supply water line (evaporator outlet) to prevent evaporator freezing under low or no flow conditions. The flow switch can be ordered as a factory installed option, as a field installed kit, or can be supplied and installed in the field. See page 12 for more information.
- Piping for units with brazed plate evaporators must have a drain and vent connection at the bottom of the bottom connection piping and at the top of the top connection piping, respectively, see Figure 8.
- These evaporators do not have drain or vent connections due to their construction. Purge air from the water system prior to unit start-up to provide adequate flow through the evaporator.
- A suitable pipe support, separate from the unit, to eliminate weight and stress on fittings and connections.
- An expansion tank and regulating valve to maintain water pressure.
- Suitable mechanical connections. All evaporators have.
- OGS type grooved water connections (adhering to AWWA C606) optionally with flanges. PVC piping should not be used.

⚠ WARNING ⚠

Polyolester oil, commonly known as POE oil, is a synthetic oil used in many refrigeration systems and is present in this Clima Flex product. POE oil, if it ever comes in contact with PVC/CPVC, will coat the inside wall of the PVC/CPVC pipe causing environmental stress fractures. Although there is no PVC/CPVC pipe in this product, keep this in mind when selecting piping materials for your application as system failure and property damage could occur. Consult the pipe manufacturer's recommendations to determine suitable pipe applications.

Figure 8. Typical piping of a brazed plate evaporator, series CLIM VS Tandem

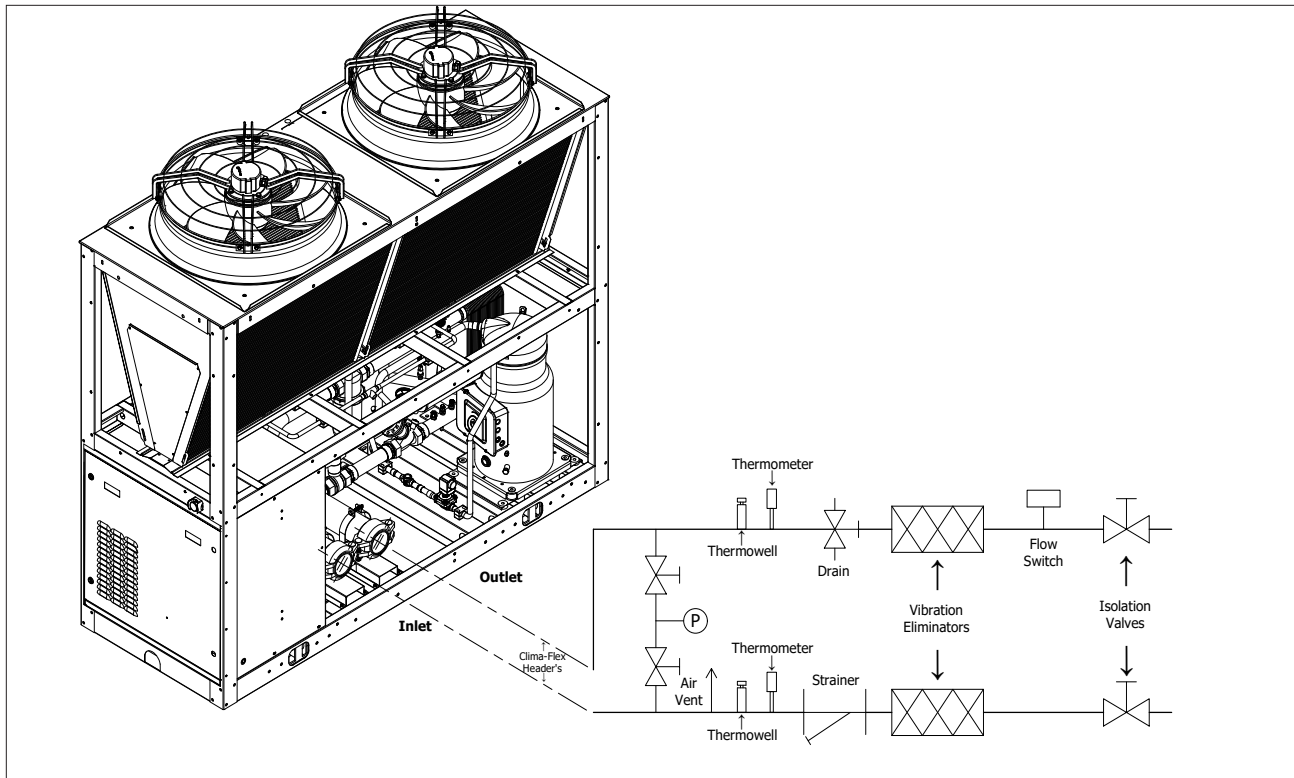

It is recommended that the field-installed water piping for the chiller include:

- Temperature sensors at evaporator inlet and outlet connections.
- Water pressure gauge connection taps and pressure gauges on evaporator inlet and outlet connections to measure water pressure drop.
- Shut-off valves to isolate the unit from piping during unit maintenance.
- Minimum bends and elevation changes to minimize pressure drop.
- Vibration eliminators on supply and return water lines to reduce transmissions to the building.
- Thorough flushing of system water piping prior to making connections to the unit evaporator.
- Insulation of the piping, including a vapor barrier, helps prevent condensation and reduces heat loss.
- Periodic water analysis and chemical treatment of the evaporator loop water is recommended immediately after unit start-up.

NOTES: Failure to comply with these measures may result in performance and reliability problems.

INLET STRAINER GUIDELINES

An inlet water filter kit must be installed in the cold water piping upstream of the evaporator inlet. There are several ways available to meet this requirement:

1. Factory installed option available - models 7.5 through 62.5
2. A field installation kit shipped loose with the unit is available for all unit sizes and consists of:
3. Y-type area strainer with 304 stainless steel perforated basket, slotted pipe connections and strainer cover [a strainer with perforations as indicated below depending on model].
4. A field supplied strainer meeting the specifications and installation requirements of this manual.

TECHNICAL DATA OF THE STRAINER

Head and neck nut: Brass
Filter element: Polyamide body coated with nylon mesh nylon mesh
Filter vessel: Trogamid T 5000 (practically impact resistant, pressure wave impact resistant, pressure wave resistant, permanently transparent, stress resistant).
 (Brass cup available on request).
 Working pressure PN 16, test pressure 25 bar, maximum water temperature 30° C. maximum water temperature 30° C, mesh size 95-140 µm.
 Available with and without Rp 1/8" pressure gauges.

Table 2. Flow rates according to DVGW test

DN 20	Rp 34	5,0 m3/h
DN 35	Rp 1	7,9 m3/h
DN 32	Rp 1 1/4	12,0 m3/h
DN 40	Rp 1 1/2	11,9 m3/h
DN 50	Rp 2	14,9 m3/h

$\Delta p = 0,2 \text{ bar:}$

INSTALLATION AND APPLICATION INFORMATION

Figure 9. Factory installed strainer

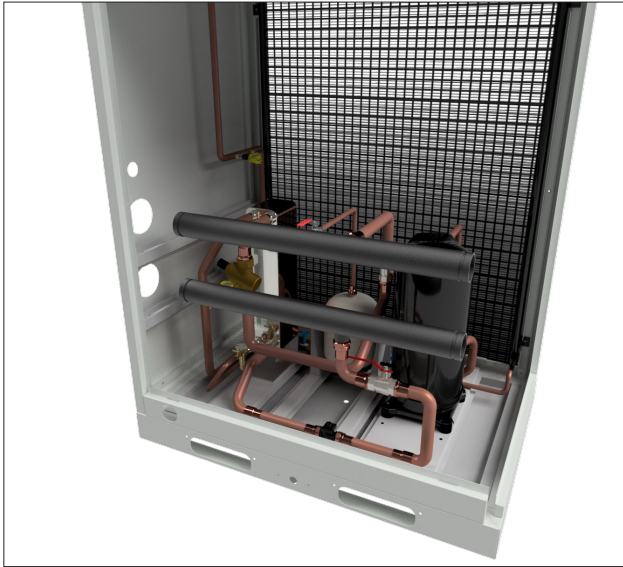

WATER FLOW LIMITATIONS

Constant evaporator flow

Maximum flow rate and pressure drop are based on a 6°F temperature drop. Flow rates above the maximum values will result in unacceptable pressure drops and may cause excessive erosion, which could lead to failure.

The minimum flow rate and pressure drop are based on a full load evaporator temperature drop of 16°F. Evaporator flow rates below the minimum values can result in laminar flow leading to low pressure alarms, fouling and poor temperature control.

VARIABLE EVAPORATOR FLOW

Reducing the evaporator flow rate in proportion to the load can reduce the energy consumption of the system. The rate of flow change should be a maximum of 10 percent of the flow per minute.

For example, if the maximum design flow rate is 200 gpm and is to be reduced to a flow rate of 140 gpm, the flow change is 60 gpm. Ten percent of 200 gpm equals a change of 20 gpm per minute, or a minimum of three minutes to go from the maximum flow to the desired flow.

If the flow rate falls below the minimum allowable, large reductions in heat transfer can occur. If the flow rate exceeds the maximum, excessive pressure drop and tube erosion can occur.

System water considerations

Reducing the evaporator flow rate in proportion to the load can reduce the energy consumption of the system. The rate of flow change should be a maximum of 10 percent of the flow per minute.

For example, if the maximum design flow rate is 200 gpm and is to be reduced to a flow rate of 140 gpm, the flow change is 60 gpm. Ten percent of 200 gpm equals a change of 20 gpm per minute, or a minimum of three minutes to go from the maximum flow to the desired flow.

If the flow rate falls below the minimum allowable, large reductions in heat transfer can occur. If the flow rate exceeds the maximum, excessive pressure drop and tube erosion can occur.

Water systems should be cleaned and flushed prior to chiller installation. Water testing and treatment should be verified during initial chiller installation/commissioning and should be maintained on an ongoing basis by water treatment professionals.

⚠ CAUTION ⚠

Improper use of detergents, chemicals and additives in the cooling system water can adversely affect the performance of the chiller and potentially result in repair costs not covered under warranty. Any decision to use these products is at the discretion of the owner/occupant/operator/user, and the owner/occupant/operator/user assumes full responsibility for any damage that may occur due to their use.

EVAPORATOR FREEZE PROTECTION

Evaporator freezing can be a problem in the application of air-cooled water chillers in sub-zero temperature areas. To protect against freezing, the evaporator comes with insulation and an electric heater. Although the evaporator is equipped with freeze protection, it does not protect the water piping external to the unit or the evaporator itself if there is a power failure or the heater burns out, or if the chiller cannot control the chilled water pumps. Use one of the following recommendations for additional freeze protection:

1. If the unit will not operate during the winter, drain the evaporator and cold water lines and flush them with glycol.
2. Add a glycol solution to the chilled water system. Breakage protection should be approximately 10°F below the minimum design ambient temperature.
3. Insulate exposed piping.
4. Add thermostatically controlled heat by wrapping lines with heat tape.
5. When glycol is added to the water system for freeze protection, the refrigerant suction pressure will be lower, the cooling performance will be lower and the water side pressure drop will be higher.

COLD WATER PUMP

It is important that the chilled water pumps are connected to and controlled by the chiller microprocessor. The controller will activate the pump whenever at least one chiller circuit is enabled for operation, whether there is a call for cooling or not. This helps ensure proper start-up sequencing of the unit. The pump will also turn on when the water temperature is below the freeze set point for longer than the specified time to help prevent evaporator freeze-up. Connection points are shown in the field wiring diagram beginning on page 25.

⚠ CAUTION ⚠

Adding glycol or draining the system is the recommended method of freeze protection. If the chiller does not have the ability to control the pumps and the water system is not drained or does not have adequate glycol at subfreezing temperatures, catastrophic evaporator failure can occur.

If the chiller is not allowed to control the pump, the following problems may occur:

1. If the chiller attempts to start without first starting the pump, the chiller will lock out with the no flow alarm and require a manual restart.
2. If the chiller evaporator water temperature drops below the “freezing set point”, the chiller will attempt to start the water pumps to prevent the evaporator from freezing.
3. If the chiller does not have the ability to start the pumps, the chiller will alarm for lack of water flow.
4. If the chiller does not have the ability to control the pumps and the water system must not be drained in sub-zero temperatures or contain glycol, the chiller may be subject to catastrophic evaporator failure due to freezing. The evaporator freeze-up rate is based on the evaporator heater and pump operation. The external brazed plate heater alone may not be able to adequately protect the evaporator from freezing without water circulation.

FLOW SWITCH

All chillers require a chilled water flow switch to verify that there is adequate water flow through the evaporator and to shut down the unit if necessary to prevent evaporator freeze-up under low or no flow conditions.

A factory-installed thermal dispersion flow switch will be installed on packaged models. On remote evaporator models, the flow switch can be supplied separately in the field, or optionally shipped loose for field installation. Terminals for field mounting and wiring of the water flow switch are provided in the unit control center.

Wire from the Y and R terminals on the switch to the terminals on the unit control panel shown in the field wiring diagrams, page 23 through page 34. Mount the flow switch on the outlet water line to shut off the unit when water flow is interrupted. A flow switch is an equipment protection control and should never be used to cycle the unit. Installation should be in accordance with the manufacturer’s instructions included with the switch. Flow switches should be calibrated to shut the unit off when operating below the minimum flow rate.

There is also a set of paddle switch contacts on the switch that can be used for an indicator light or alarm to indicate when a “no flow” condition exists. Protect any flow switch that is installed outdoors from freezing. It is not recommended that differential pressure switches be installed outdoors. They may freeze and not indicate a no-flow condition.

Protect any flow switches that are installed outdoors from freezing. It is not recommended to install differential pressure switches outdoors. They may freeze and not indicate a no-flow condition.

GLYCOL SOLUTIONS

The use of glycol can affect system performance depending on its concentration and should be taken into account during initial system design. When glycol is added to the chilled water system to protect against freezing, it should be noted that the refrigerant suction pressure will be lower, the cooling performance will be lower and the water side pressure drop will be higher. The reduction in performance depends on the glycol concentration and temperature. Test the coolant with a clean and accurate glycol refractometer to determine the freezing point.

⚠ CAUTION ⚠

The installed glycol level must match the nominal glycol percentage indicated on the submitted chiller technical data sheet. Failure to meet the nominal glycol percentage may result in damage to the unit and loss of unit warranty.

⚠ CAUTION ⚠

Do not use automotive grade antifreeze. Industrial grade glycols should be used. Automotive antifreeze contains inhibitors that will cause plaque formation on the cooler evaporator copper tubes. The type and handling of the glycol used should be consistent with local codes.

CONDENSER COIL OPTIONS AND COATING

Considerations

The standard CLIM VS Series chiller coils have an aluminum alloy microchannel design with a series of flat tubes containing multiple parallel flow microchannels placed between the coolant manifolds. The microchannel coils are designed to withstand the synthetic acidified seawater acidified (SWAAT) mist test of over 1000 hours (ASTM G85-02) at 120°F (49°C) with 0% loss and without developing leaks.

Epoxy coating: is an extremely flexible and durable water-based polymer coating that is uniformly applied to all coil surfaces by a multi-step electrostatic submerged coating process. Epoxy-coated coils offer ASTM B117-90 salt spray resistance of more than 10,000 hours, applied to both the coil and the coil heads. Epoxy-coated coils also receive a UV-resistant urethane topcoat to provide superior resistance to degradation from direct sunlight.

NOTES:

1. **Non-corrosive environments can be estimated by the appearance of existing equipment in the immediate area where the chiller is to be placed.**
2. **Marine environments should take into account the proximity to the coast, as well as the prevailing wind direction.**
3. **Industrial contaminants can be general or localized, depending on the immediate source of contamination (e.g. diesel fumes due to proximity to a loading dock).**
4. **The marine-industrial combination is influenced by proximity to the coast, prevailing winds, and general and localized sources of pollution.**

Table 3. Coil and liner selection matrix

Coil Option	Non-corrosive ¹	Unpolluted marine ²	Industrial ³	Combined marine-industrial ⁴
Standard Microchannel	+++	-	-	-
Epoxy Coated coils	+++	+++	+++	++

REFRIGERATION SCHEMATICS

Figure 10. CLIM VS refrigeration schematics

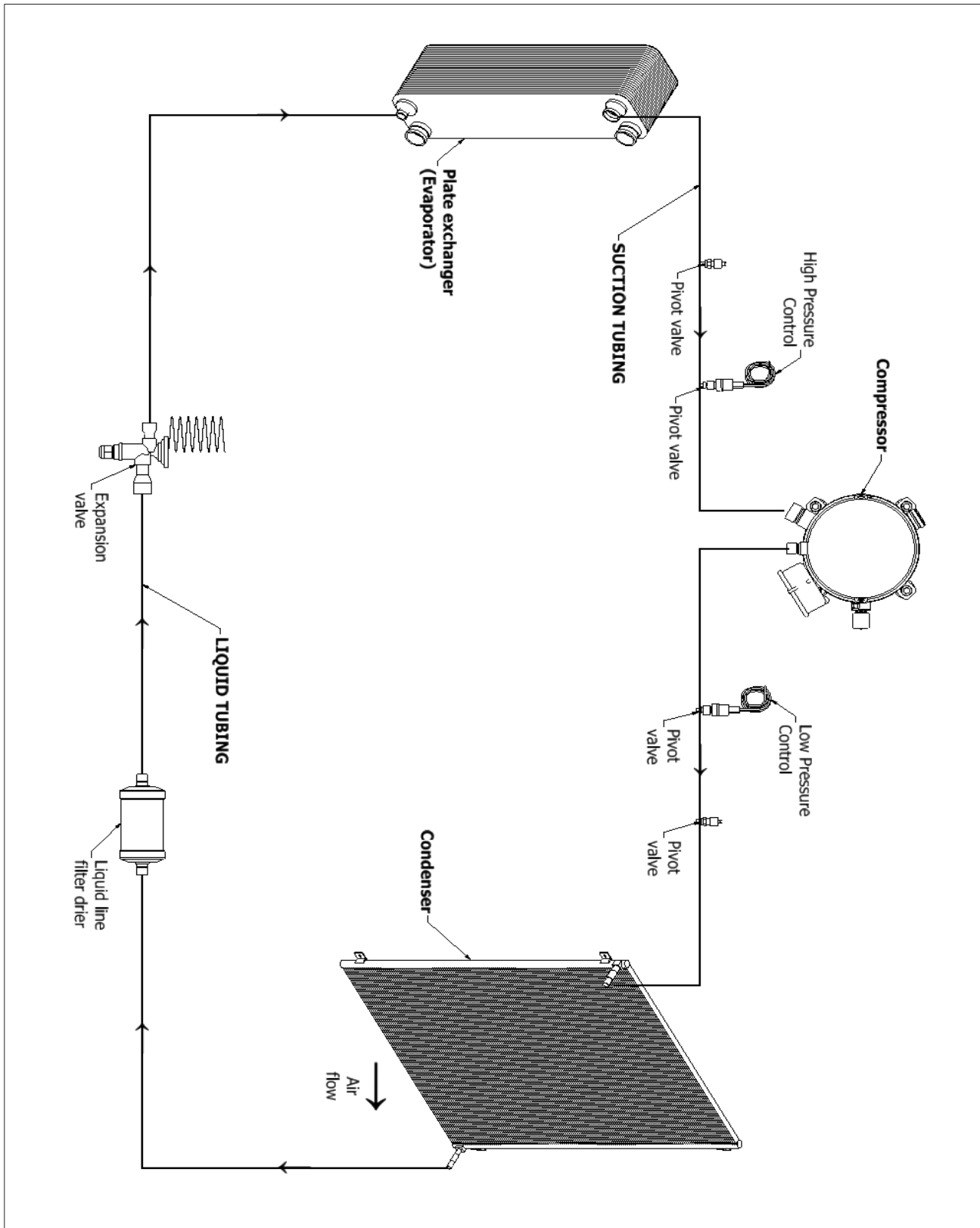
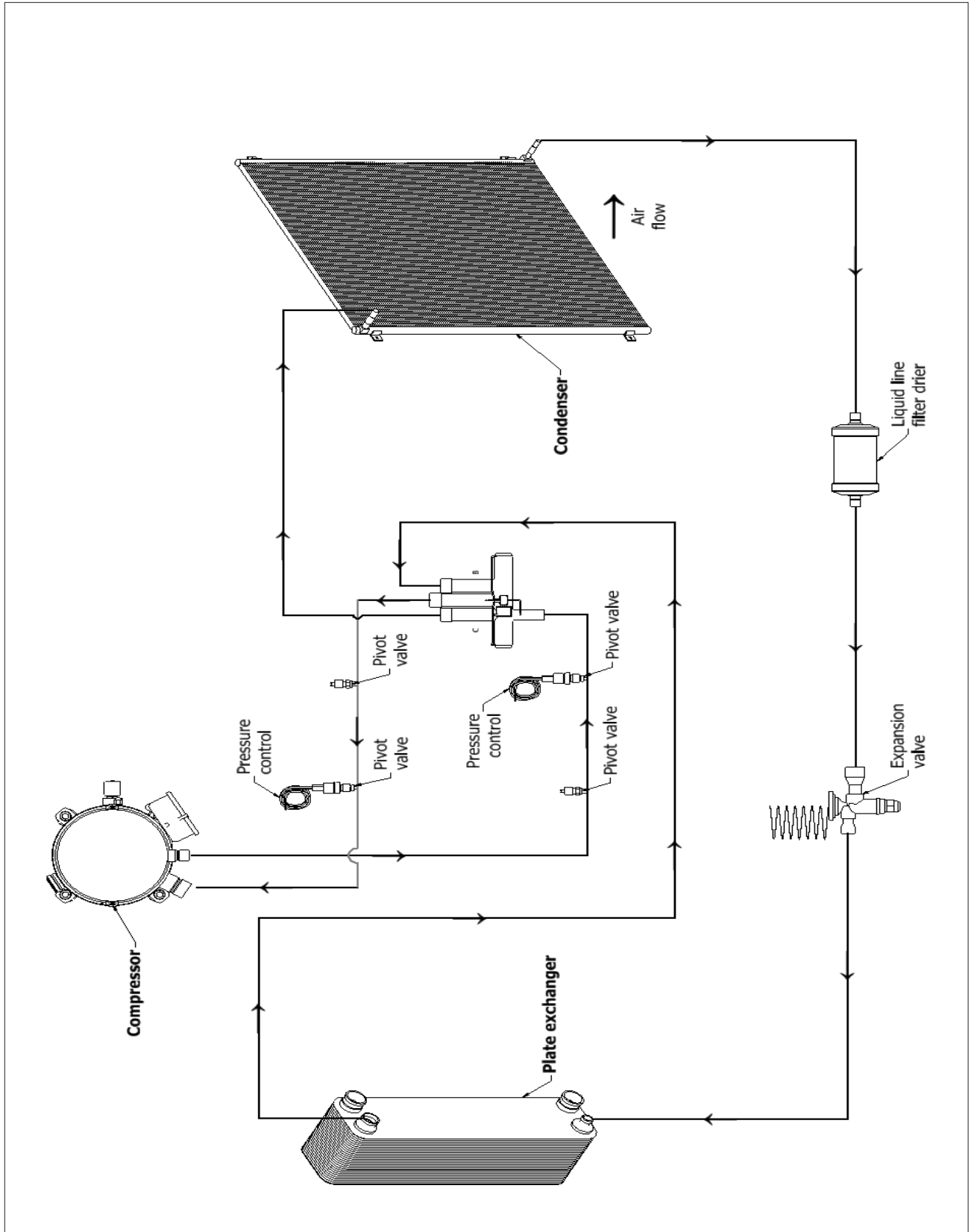

Figure 11. CLIM VS heat pump refrigeration schematic



DIMENSIONS AND WEIGHTS - PACKAGED UNITS

Figure 12. CLIM VS 7.5 Tr

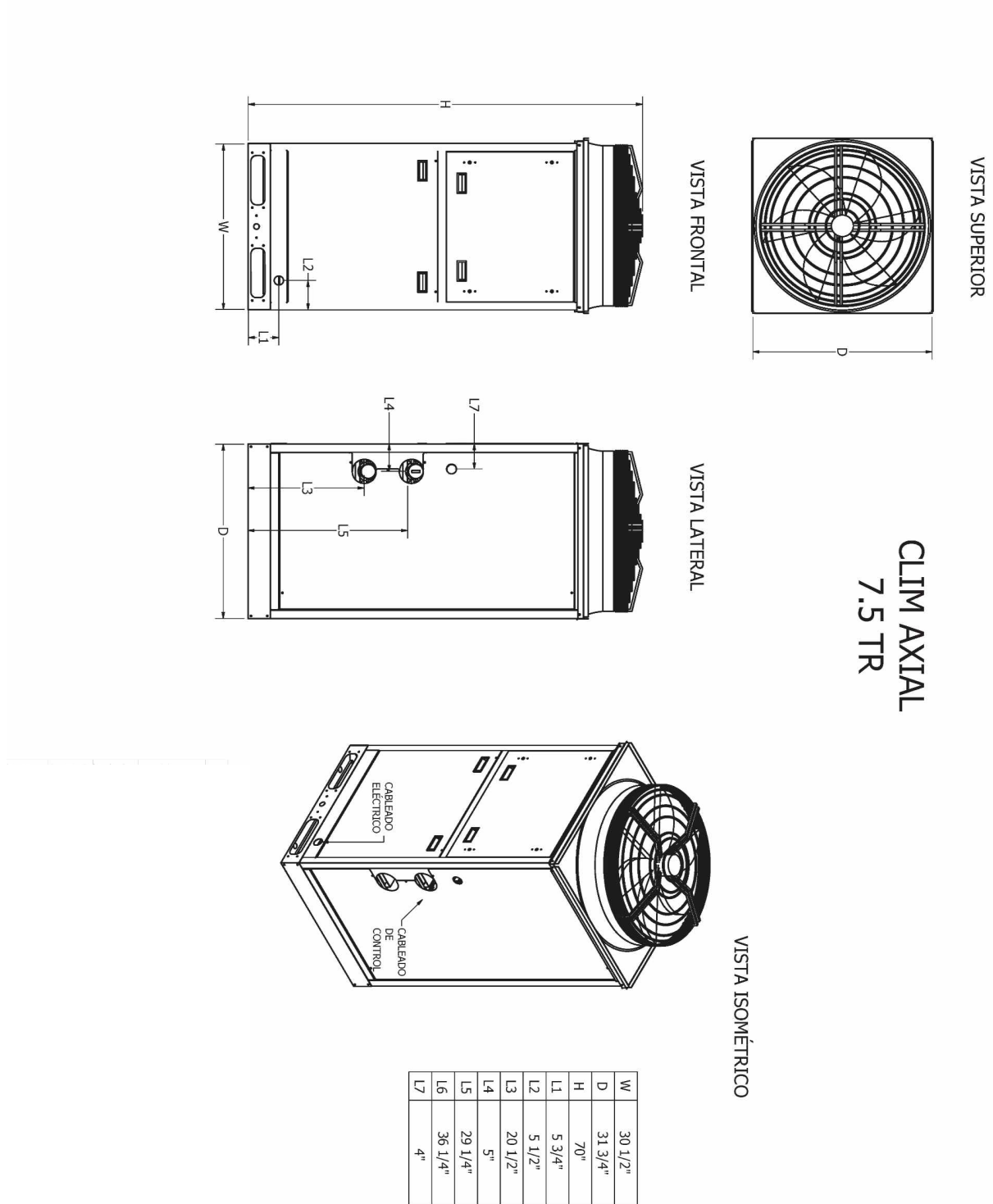
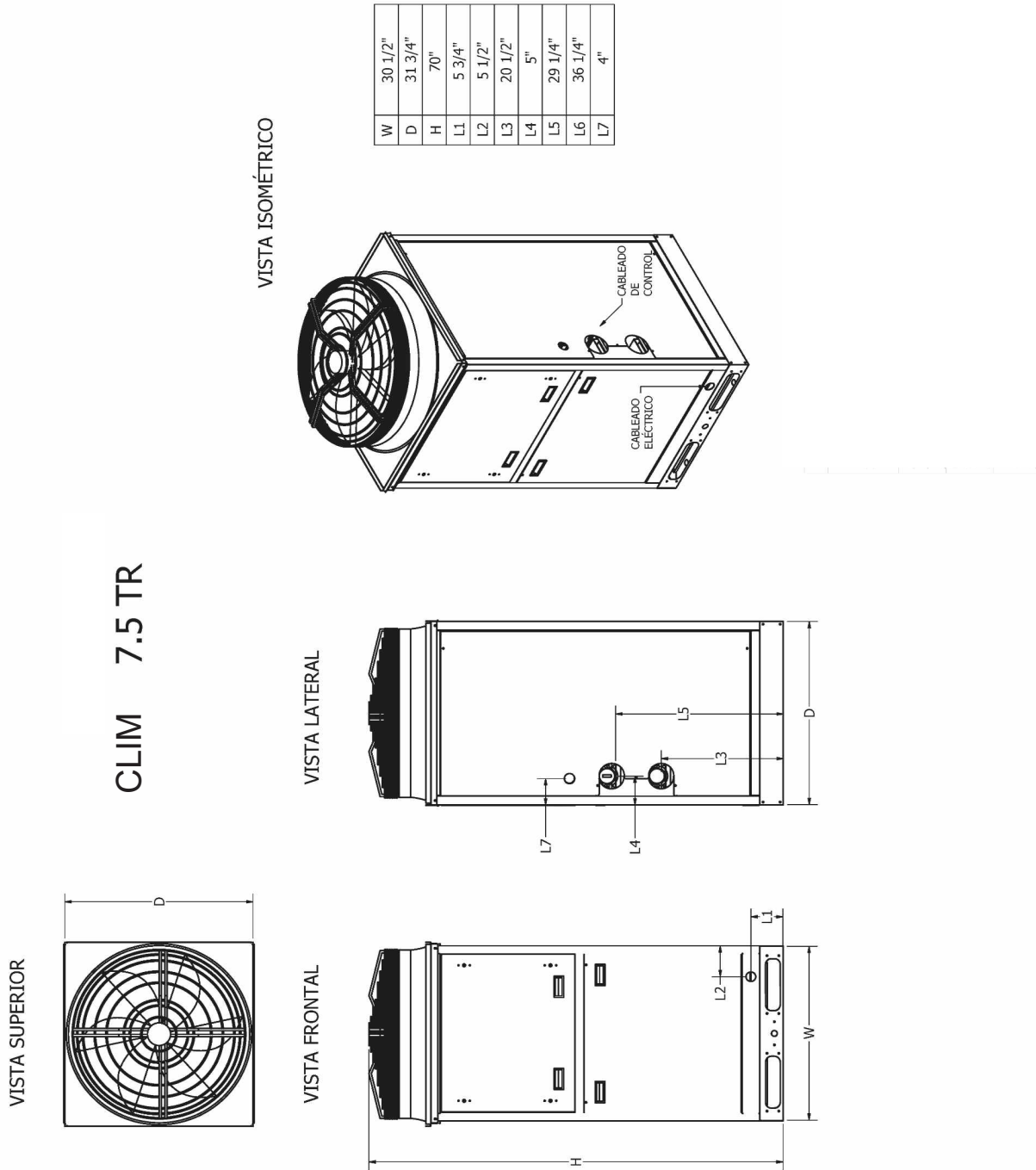
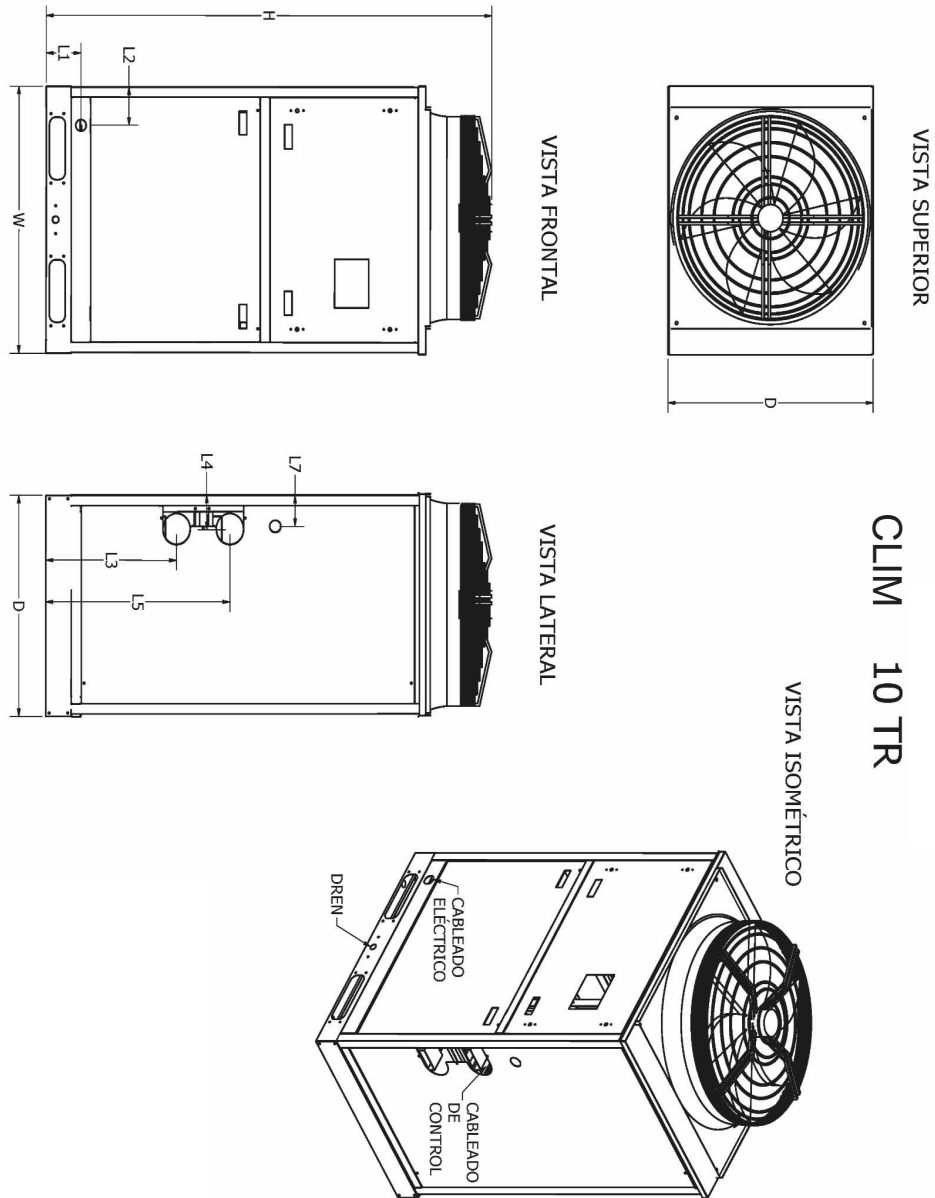

Figure 13. CLIM VS 10 Tr



DIMENSIONS AND WEIGHTS - PACKAGED UNITS

Figure 14. CLIM VS 12.5 Tr



W	38 1/4"
D	31 3/4"
H	70"
L1	5 3/4"
L2	5 1/2"
L3	20 1/2"
L4	5"
L5	29 1/4"
L6	36 1/4"
L7	4"

Figure 15. CLIM VS

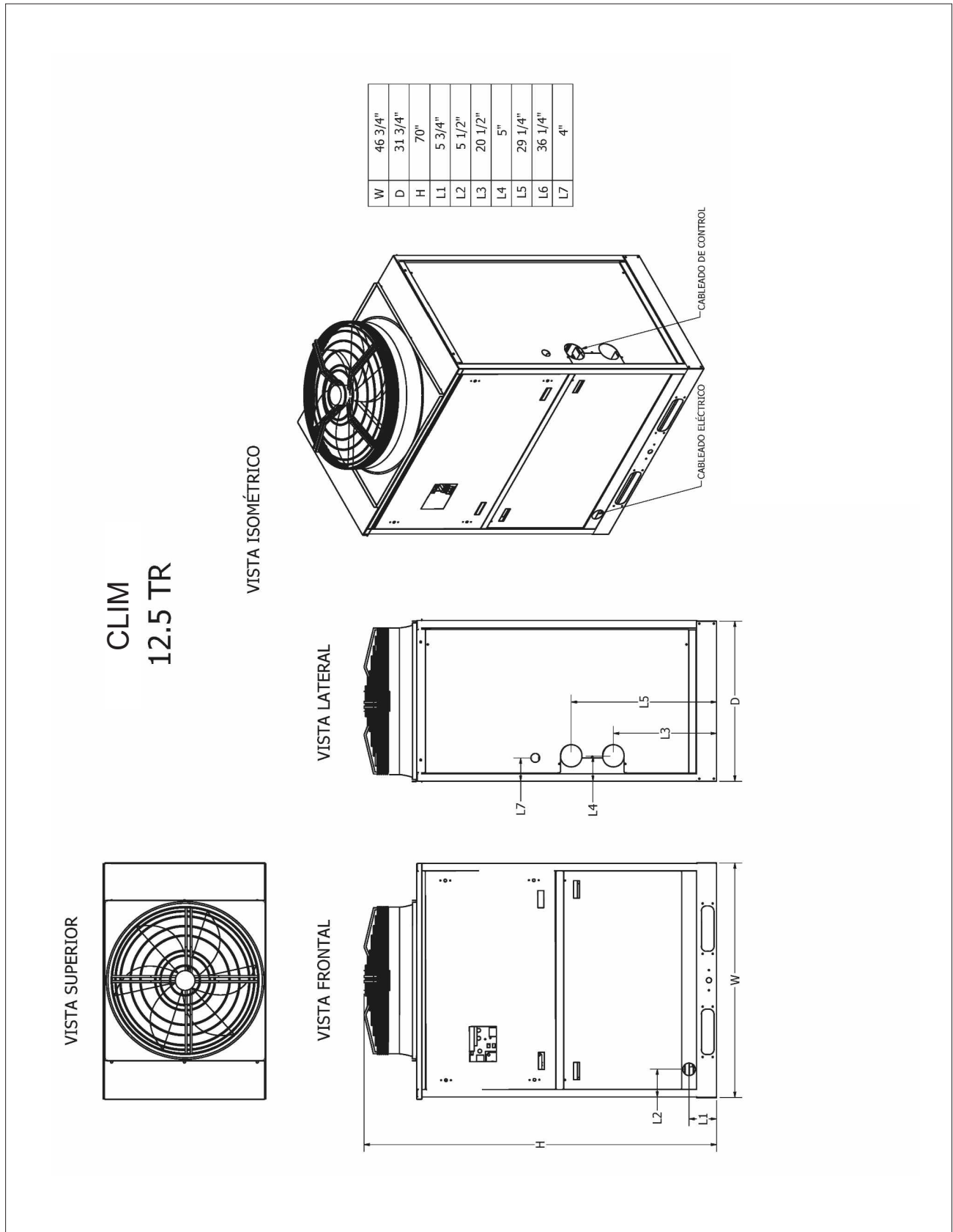

DIMENSIONS AND WEIGHTS - PACKAGED UNITS

Figure 16. CLIM VS heat pump

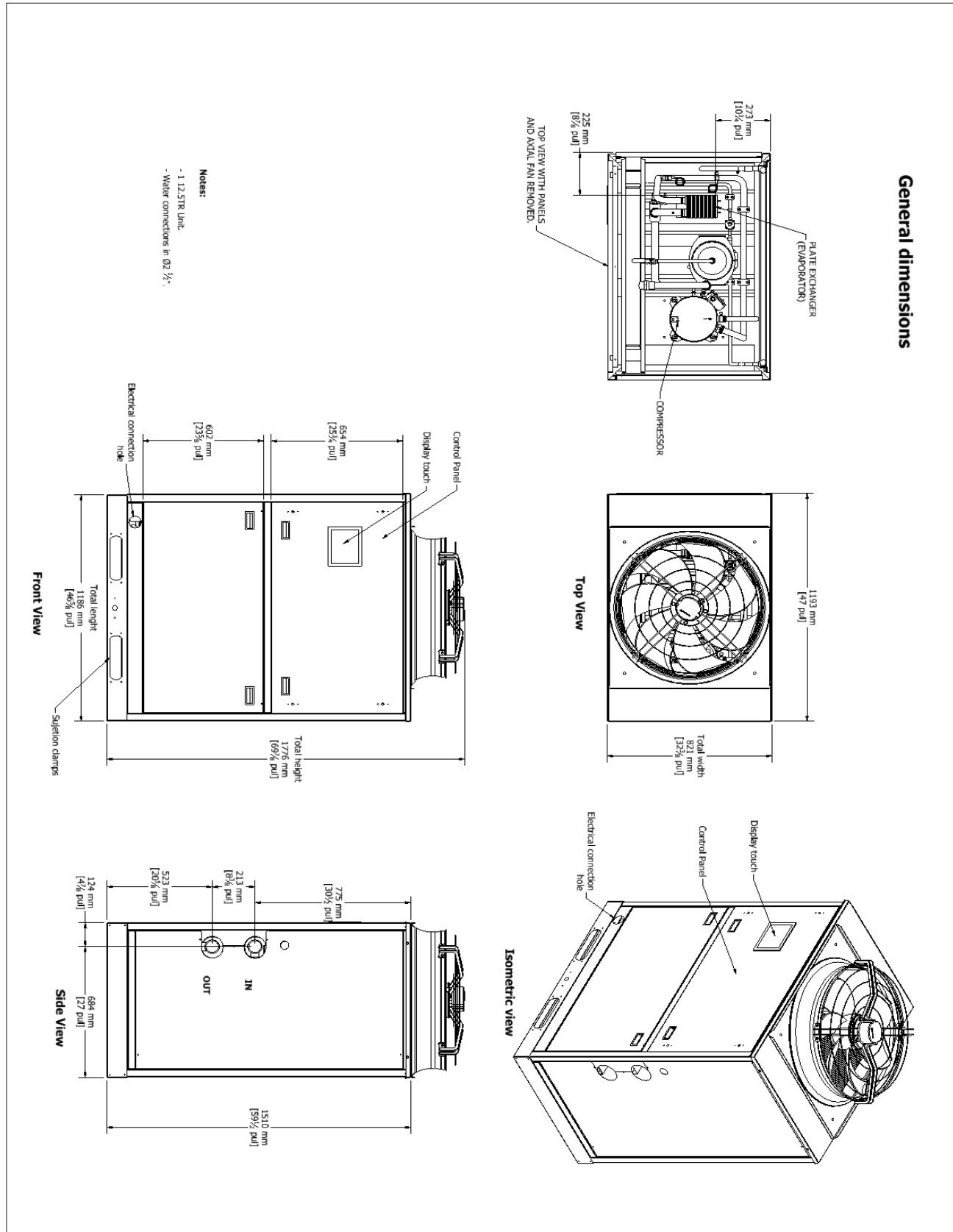
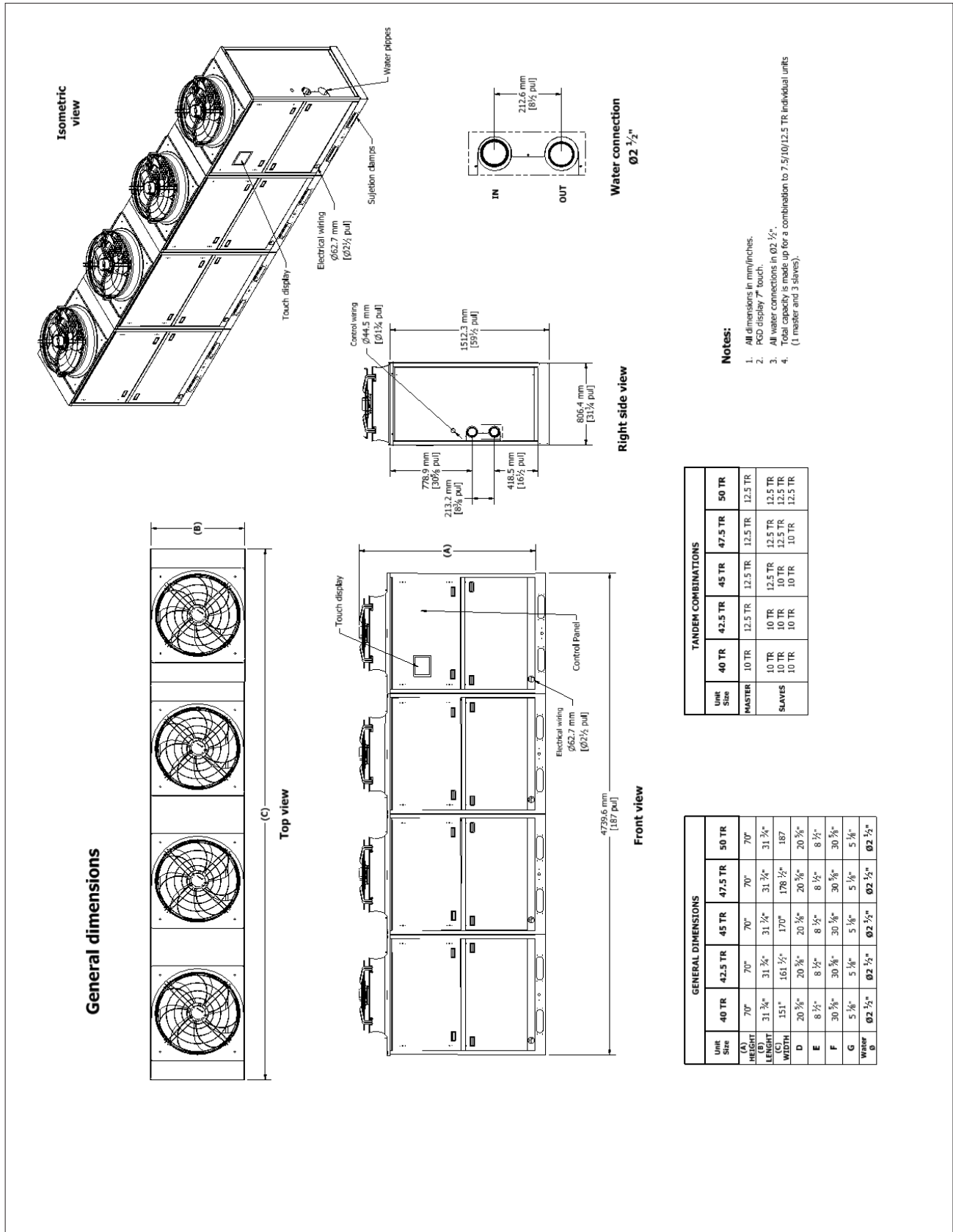

Figure 17. CLIM VS tandem 50 Tr



REFRIGERANT CHARGE

EMPTYING PROCEDURE

Any system that has been exposed to the atmosphere must be properly dehydrated. This is achieved with a proper vacuum procedure. To achieve a proper vacuum, a VACUUM PUMP (not a compressor) and a VACUOMETER are required.

The procedure is as follows:

- First of all, the access points to the system must be defined. For both the low side (suction line) and the high side (liquid line), use the existing service valves on the condensing unit, i.e. the high pressure switch, connected to the smaller diameter pipe, and the low pressure switch, connected to the larger diameter pipe.
- Once this is done, the system can be evacuated.

Basically, it can be done in two ways:

• DILUTION METHOD

1. Turn on the vacuum pump and build up vacuum in the pump (register 1 closed).
2. Open register 1 and let the system evacuate until at least 500 mice are reached. To obtain the measurement, close register 1 and open register 2 and make the vacuum gauge feel the system pressure. After reaching 500 mice, isolate the vacuum pump and open register 3, letting the Nitrogen pass through to break the vacuum. Isolate the Nitrogen tube.
3. Vent the Nitrogen through the connection between the copper line and register 3.
4. Repeat the operation at least twice, making the third evacuation in the last phase. At the end at least 200 mice should be obtained.

⚠ WARNING ⚠

Never disconnect the copper tubing from register 3, simply loosen the connection to purge the nitrogen.

To obtain an accurate vacuum value, isolate the vacuum pump from the system by closing register 1 and waiting about 5 minutes for an accurate measurement. If the value does not hold, the system still has moisture or there is a leak. Always check all connections (points 1, 3 and valves).

• HIGH VACUUM METHOD

1. It is applied with a vacuum pump capable of achieving a vacuum of less than 200 microns in a single evacuation. Proceed as follows:
2. Turn on the vacuum pump and then open the register1 (Fig. 18). Subsequently, isolate the vacuum pump and open the register1 (fig. 18).
3. When a value of less than 200 microns is obtained (try to reach the lowest possible value), the vacuum procedure is finished.

⚠ WARNING ⚠

The pump oil should be changed periodically to ensure vacuum efficiency.

REFRIGERANT CHARGE

After evacuating the system properly, close the manifold registers and isolate the vacuum pump, vacuum gauge and nitrogen tube.

To make the refrigerant gas charge, replace the nitrogen tube (Figure 18) with a refrigerant gas tube. Purge the hose connecting the tube to the service valve.

Open the service valve that provides access to the refrigerant gas tube and then the manifold discharge port.

To properly charge the system, check the unit identification labels for the amount of refrigerant gas to be added to the system.

With the system stopped, charge the liquid refrigerant gas through the liquid line service valve (smaller diameter). To assist you, use a scale (if a graduated tube is not used). Wait at least 10 minutes before turning on the equipment.

Close the manifold discharge register, open the suction register and with the system running complete the charge with refrigerant gas in gas form (5% to 20% of the total). Check on the scale the weight of the refrigerant gas that was added to the system. If the charge is complete, close the manifold suction register, disconnect the suction and discharge hoses and close the pipe register.

The loading procedure is completed.

REFRIGERANT GAS COLLECTION

If for any reason there is a need to remove/lose refrigerant gas, the service valves on these units allow the refrigerant gas to be collected from the system inside the condensing unit.

Procedure:

1. Connect the manifold hoses to the service valve ports of the condensing unit.
2. Close the 1/4" liquid line service valve.
3. Turn the unit on cool down observing that the system pressures reach 2 psi.

At this time close the 3/8" suction line service valve to allow the refrigerant gas to be collected.

NOTES: The refrigerant must be adjusted by 20% to reach the evaporating temperature. You can check the charge on the next page.

Table 5. Refrigerant charge

REFRIGERANT CHARGE			PRESSURE RANGES		
MODEL	TR	Refrigerant (Lbs)	Refrigerant (Kg)	PRESSURE RANGES	LOW PRESSURE
CLIM VS	12.7	7 - 9	3.1 - 4.0	420 - 480 psi	100 - 120 psi
CLIM VS	10	6 - 8	2.7 - 3.6	420 - 480 psi	100 - 120 psi
CLIM VS	7.5	5 - 7	2.3 - 3.1	420 - 480 psi	100 - 120 psi

Figure 18. Diagram for obtaining vacuum and for refrigerant charge

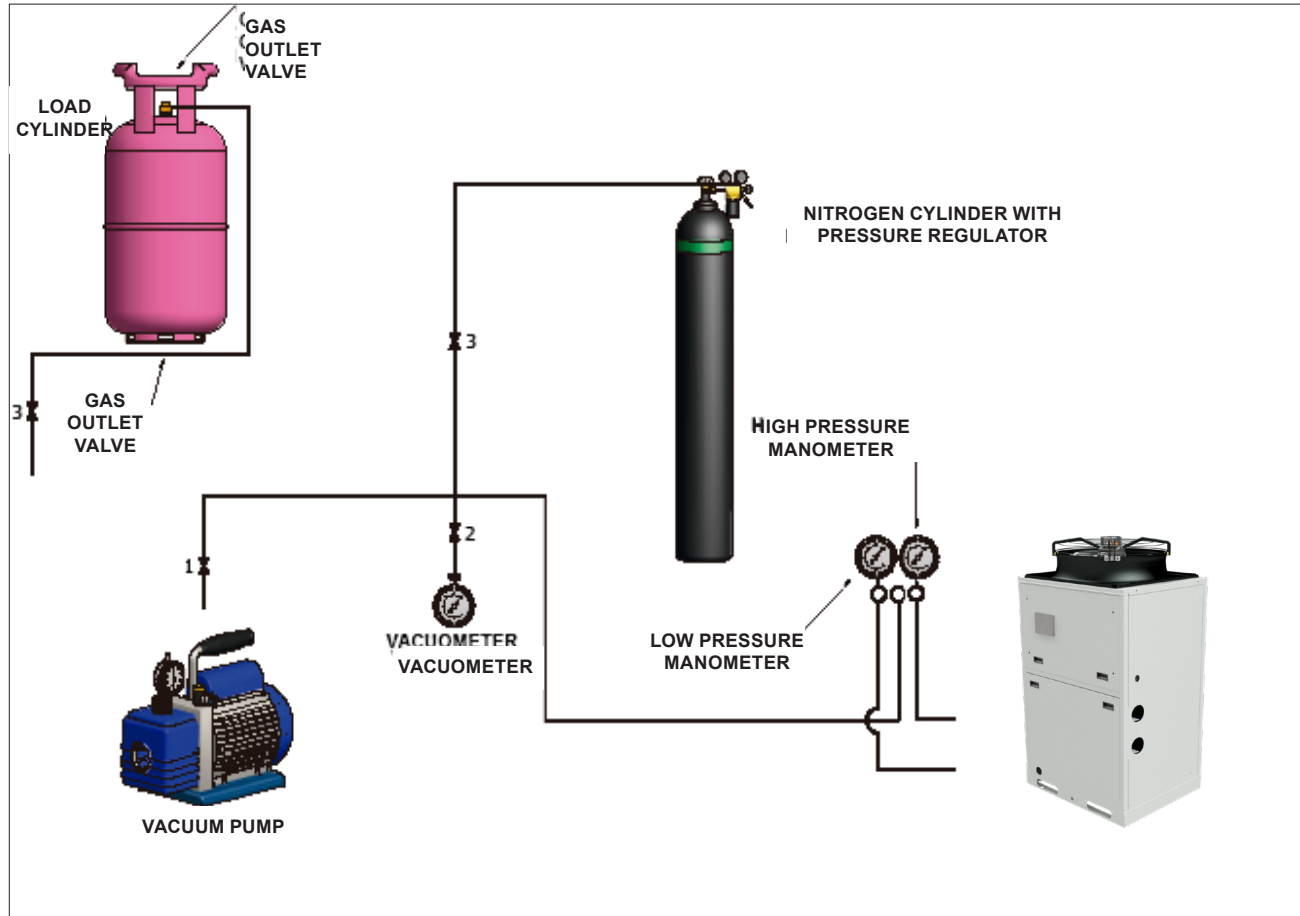

Table 4. Evaporator Pressure Drop Data

UNIT	CAPACITY	# MODULE	EVAPORATOR DROP	TOTAL DROP
			DP (FT WG)	DP (FT WG)
M	5	1	16.7	31.5
M	7.5	1	16.7	31.5
M	10	1	16.7	31.5
M	12.5	1	16.7	31.5
M(1)+E(1)	20	2	16.7	31.8
M(1)+E(2)	30	3	16.7	32.6
M(1)+E(3)	40	4	16.7	34.1
M(1)+E(3)	50	4	16.7	34.1
M(1)+E(4)	62.5	5	16.7	36.5

ELECTRICAL DATA

ELECTRICAL CONNECTION

CLIM VS units can be ordered with standard multi-point power connections or with optional single-point connections and various disconnect and circuit breaker options. Wiring inside the unit is sized in accordance with the NEC®.

The required field wiring varies depending on the configuration of the unit.

Voltage limitations are:

1. Within 10 percent of nameplate rating.
2. Voltage unbalance must not exceed 2 percent. Since a voltage unbalance of 2 percent can cause a current unbalance of 6 to 10 times the voltage unbalance per NEMA MG-1, it is important that phase-to-phase unbalance be kept to a minimum.

⚠ DANGER ⚠

Qualified and licensed electricians must perform wiring. There is a danger of electrical shock that can cause serious injury or death.

Chiller electrical wiring connections may be made with either copper or aluminum wiring, provided the size and number of wires match the chiller terminals. All wiring must be in accordance with applicable local and national codes, including NECA/AA 10402012 for installation of aluminum wiring in buildings (ANSI).

The wiring inside the unit is sized in accordance with the NEC®. Refer to the unit nameplate and unit selection report for correct electrical ratings.

1. The control transformer is supplied and no separate 115V power is required. For single and multipoint power connections, the control transformer is on circuit #1 with control power wired from there to circuit #2. For multipoint power, disconnecting power from circuit #1 disconnects the control power from the unit.
2. The size of the wiring supplied to the control panel should be in accordance with the field wiring diagram.
3. The single point power supply requires a single disconnect to supply electrical power to the unit. This power supply must have a fuse or use a circuit breaker.
4. All field wiring terminal range values listed in the unit selection report apply to 75°C cable per NEC.
5. It must be grounded per national and local electrical codes.

⚠ CAUTION ⚠

Static discharge during handling of the circuit boards can cause damage to the components. Use an antistatic strap before performing any maintenance work. Never unplug cables, circuit board terminal blocks or plugs while the panel is powered.

USE WITH ON-SITE GENERATORS

Switching from site mains to generator power and vice versa requires the chiller to be off or the power to be disconnected for more than five seconds to avoid sending out-of-phase voltage to the chiller.

A properly installed and fully synchronized automatic transfer switch must be used to transfer power if the chiller is operating under load.

Generator sizing

⚠ WARNING ⚠

The generator should be sized by an electrical engineer familiar with generator applications.

Transfer Back To The Grid

Proper transfer of power from the standby generator to the grid is essential to prevent damage to the chiller and must be used to ensure proper operation of the unit.

⚠ WA4RNING ⚠

Stop the chiller before transferring power from the generator to the mains. Transferring power while the chiller is running can cause serious damage to the chiller.

The procedure required to reconnect generator power to the grid is as follows:

1. Set the generator to always run five minutes longer than the unit start timer, which can be set from two to sixty minutes, while keeping the chiller powered by the generator until the fully synchronized Automatic Transfer Switch properly delivers chiller power from the site.
2. Set the transfer switch supplied with the generator to automatically shut down the chiller before the transfer is made. The automatic shutdown function can be accomplished through a BAS interface or with the "remote on/off" wiring connection shown in the field wiring diagrams.

A start signal can be given at any time after the stop signal, as the three-minute start timer will be in effect.

⚠ WA4RNING ⚠

Electric shock danger. Improper handling of this equipment can cause personal injury or equipment damage. This equipment must be properly grounded. Control panel connections and maintenance should be performed only by personnel knowledgeable in the operation of the equipment being controlled. Disconnect electrical power before servicing equipment. Be sure to install a earth leakage breaker. Failure to install a earth leakage breaker may result in electric shock or fire.

⚠ WARNING ⚠

When installing the earth leakage protector make sure that it is compatible with the inverter (resistant to high frequency electrical noise) to avoid unnecessary opening of the earth leakage protector.

Figure 19. Typical field wiring diagram of 220V master cold only unit (single point connection with all options shown)

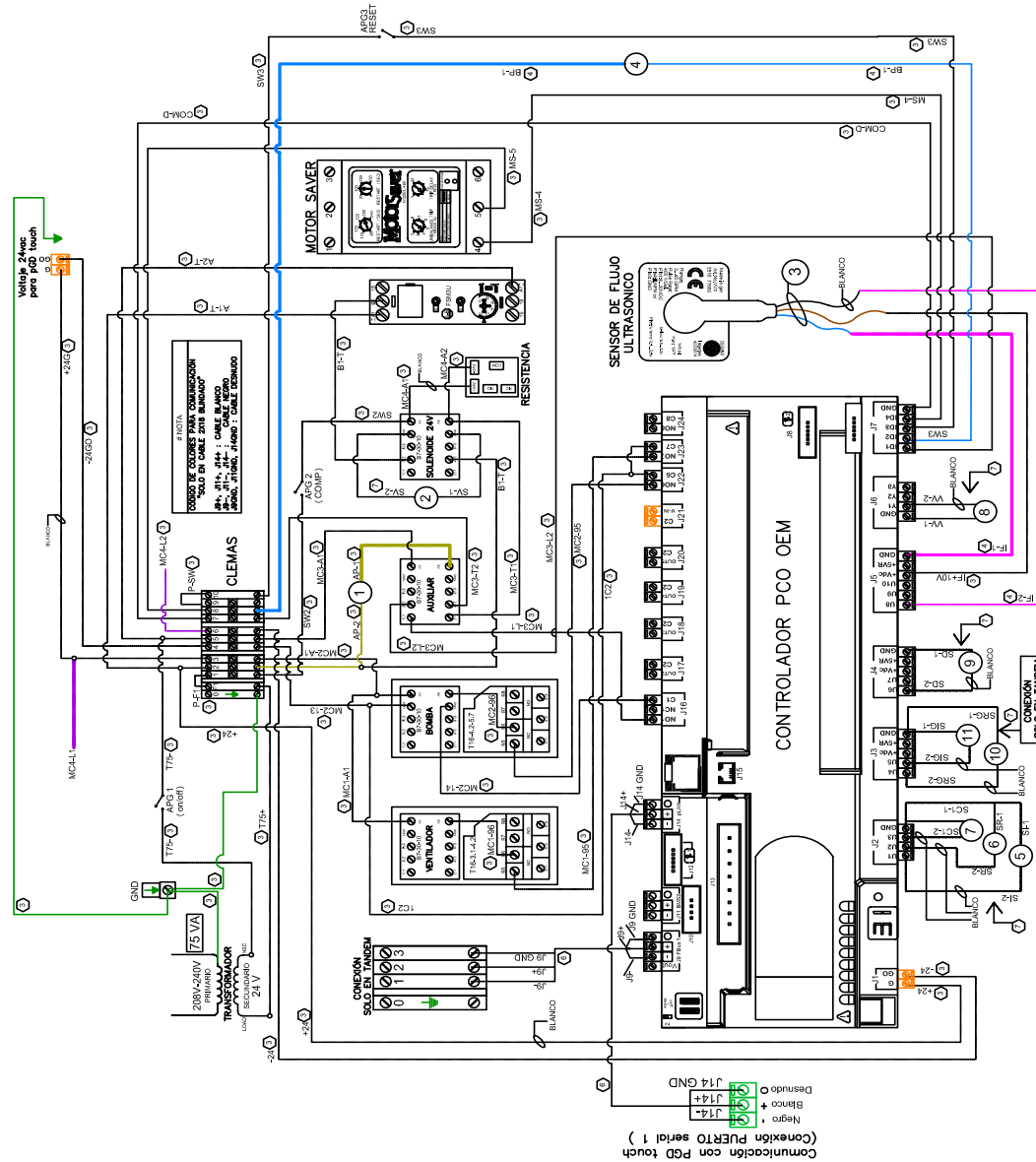

# CONCEPTO	
1	SENSOR DE ALTA PRESIÓN
2	START DE VAREADOR PARA COMPRESOR
3	INTERRUPTOR DE FLUJO ULTRASONICO
4	SENSOR DE BAJA PRESIÓN
5	SENSOR DE INYECCIÓN
6	SENSOR DE CONGELAMIENTO
7	75 V/A
8	VOLTAJE 0...10VDC PARA VAREADOR
9	SENSOR DE CONDENSADOR
10	SENSOR INYECCIÓN GENERAL(Opcional)
11	SENSOR RETORNO GENERAL(Opcional)
# TIPO DE COLOR DE CABLE	
	CABLE COLOR RAYADO
	CABLE COLOR SÓLIDO
# SIMBOLOGÍA	
○	SEÑALIZACIÓN COLOR DE CABLE/CALEBRE
○	APAGADOR 1 POLO 1 TIPO
○	REFERENCIA A PUNTO DE CONEXIÓN (APG) REFERENCIA INTERRUPTOR CONEXIÓN A TIERRA
# ESPECIFICACIÓN DE CALIBRE DE CABLE	
1	CABLE CALIBRE 3 X 8 AWG BUNDAO
2	CABLE CALIBRE 8 AWG
3	CABLE CALIBRE 14 AWG
4	CABLE CALIBRE 16 AWG
5	CABLE CALIBRE 18 AWG
6	CABLE CALIBRE 3 X 18 AWG
7	CABLE CALIBRE 2 X 18 AWG BUNDAO
8	CABLE CALIBRE 2 X 22 AWG
9	CABLE CALIBRE 4 AWG
10	CABLE CALIBRE 2 AWG
11	CABLE CALIBRE 6 AWG
12	CABLE CALIBRE 10 AWG
13	CABLE CALIBRE 3 X 2 AWG BUNDAO
14	CABLE CALIBRE 4 X 14 AWG USO RUDO
15	CABLE CALIBRE 3 X 16 AWG USO RUDO
# TIPO DE SEÑAL	
	ALTO VOLTAJE "CLASE 1"
	BAJO VOLTAJE "CLASE 2"
	SEÑAL DE RESISTENCIA
	SEÑAL DIGITAL
# NOTA	
0	CUALQUIER FUENTE DE CABLE EN CONTROL FUERZA DE CORRIENTE DE IR EN COLOR BLANCO - CALIBRE 16.

Comunicación con PGD touch (Conexión FUERTO serial 1)

Desnudo + J14 GND
Negro + J14
Blanco + J14

ELECTRICAL DATA

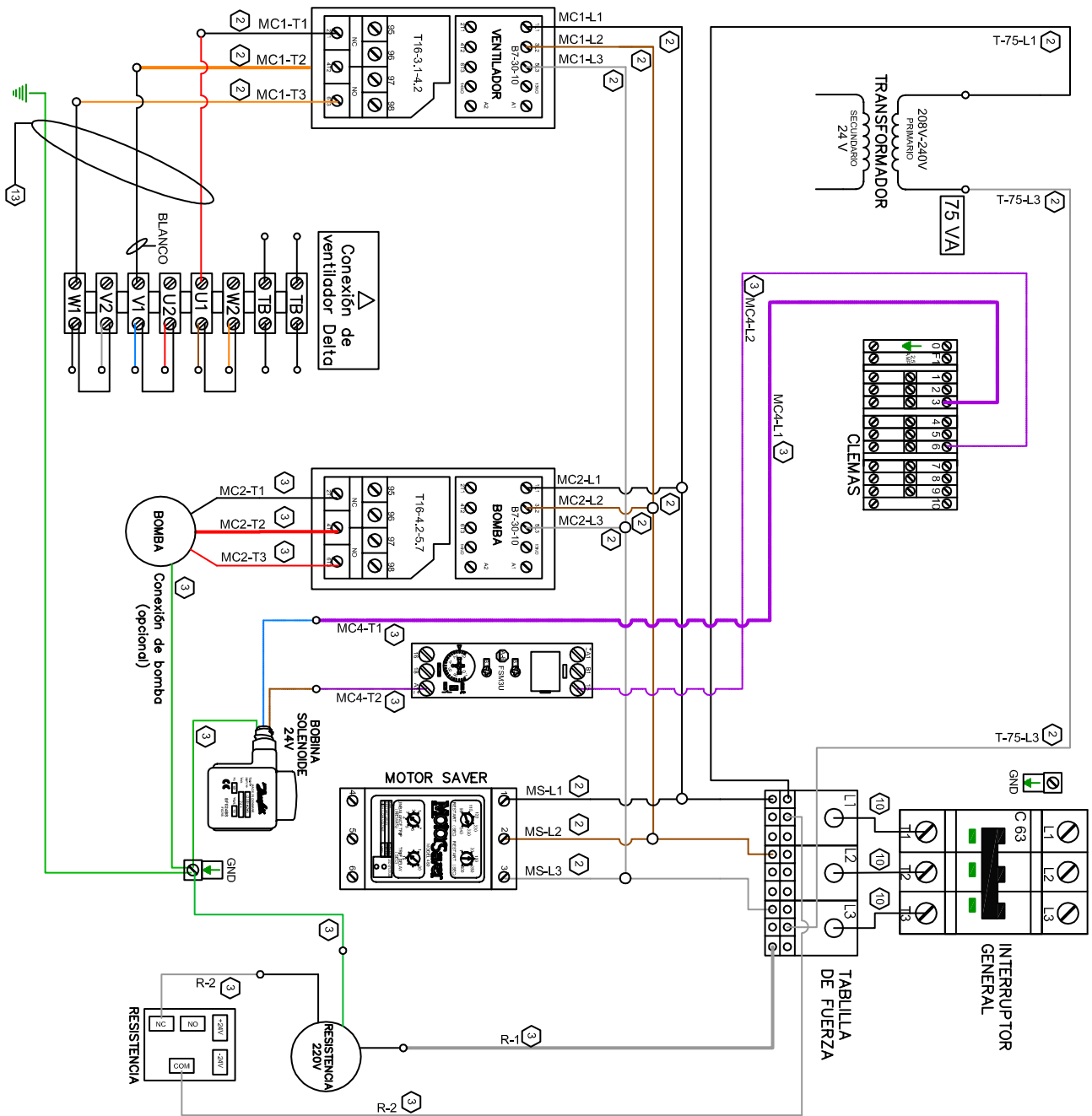

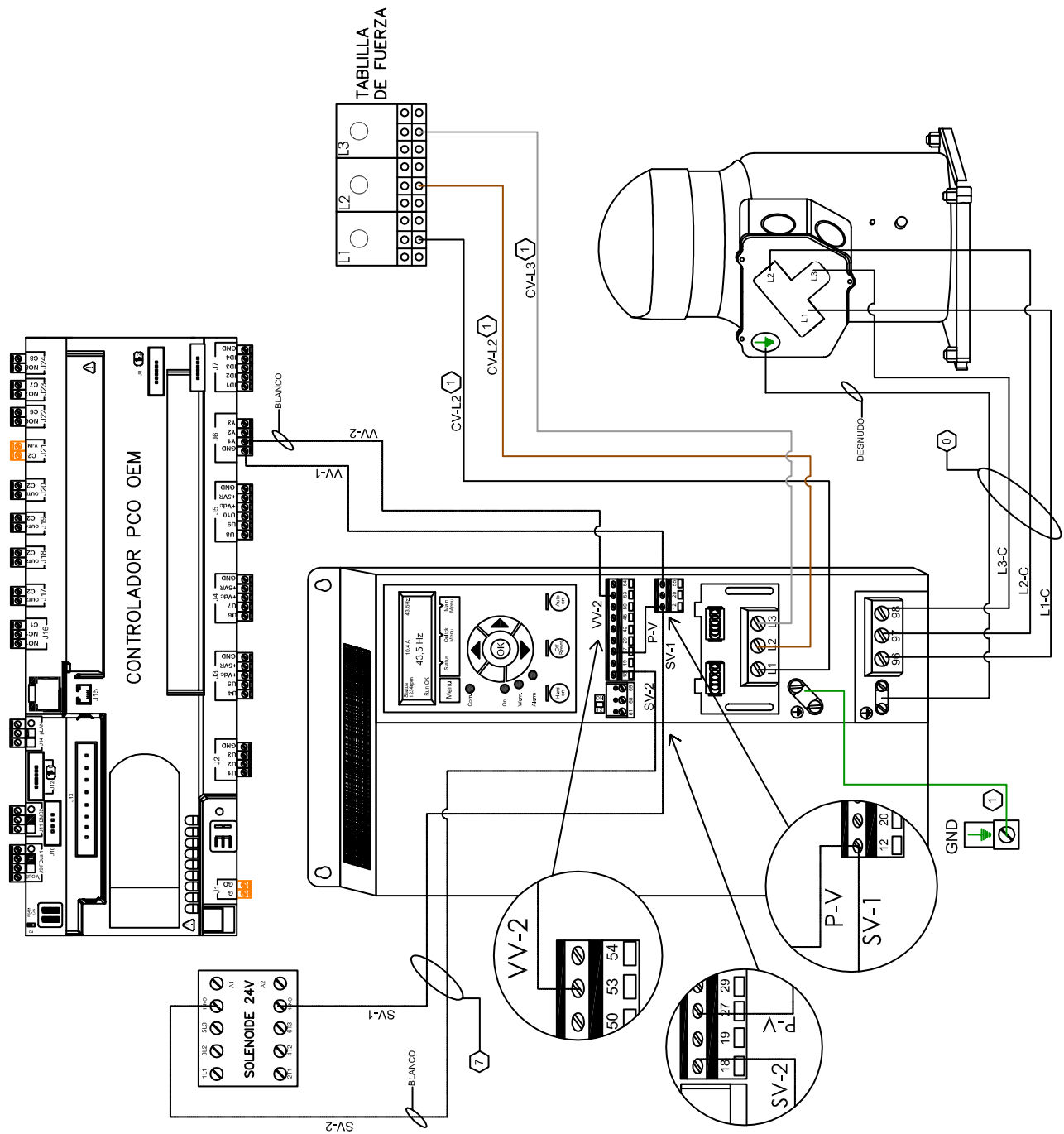

ELECTRICAL DATA

Figure 20. Typical field wiring diagram of the 220v slave only cold unit (single point connection with all options shown)

REF.	DESCRIPCIÓN	CANT.	UNID.
100001	SENSOR DE ALTA PRESION	1	220V
100002	SENSOR DE BAJA PRESION	1	220V
100003	INTERRUPTOR DE FLUIDO ULTRASONICO	1	220V
100004	SENSOR DE INYECCION	1	220V
100005	SENSOR RETORNO	1	220V
100006	SENSOR DE CONGELAMIENTO	1	220V
100007	SENSOR DE CONDENSADOR	1	220V
100008	TIPO DE COLOR DE CABLE	1	220V
100009	CABLE COLOR RAYADO	1	220V
100010	CABLE COLOR SOLIDO	1	220V
100011	SEÑALIZACION COLOR DE CABLE/CABLE	1	220V
100012	APAGADOR 1 POLO 1 TIPO	1	220V
100013	REFERENCIA A PUNTO DE CONEXION	1	220V
100014	REFERENCIA INTERRUPTOR	1	220V
100015	CONEXION A TIERRA	1	220V
100016	ESPECIFICACION DE CALIBRE DE CABLE	1	220V
100017	CABLE CALIBRE 3 X 8 AWG BUNDADO	1	220V
100018	CABLE CALIBRE 8 AWG	1	220V
100019	CABLE CALIBRE 14 AWG	1	220V
100020	CABLE CALIBRE 18 AWG	1	220V
100021	CABLE CALIBRE 2 X 18 AWG BUNDADO	1	220V
100022	CABLE CALIBRE 2 X 22 AWG	1	220V
100023	CABLE CALIBRE 4 AWG	1	220V
100024	CABLE CALIBRE 6 AWG	1	220V
100025	CABLE CALIBRE 10 AWG	1	220V
100026	CABLE CALIBRE 3 X 2 AWG BUNDADO	1	220V
100027	CABLE CALIBRE 4 X 14 AWG USO RUIDO	1	220V
100028	CABLE CALIBRE 3 X 18 AWG USO RUIDO	1	220V
100029	TIPO DE SERIAL	1	220V
100030	ALTO VOLTAJE "CLASE 1"	1	220V
100031	BAJO VOLTAJE "CLASE 2"	1	220V
100032	SERIAL DE RESISTENCIA	1	220V
100033	SERIAL DIGITAL	1	220V
100034	NOTA	1	220V
100035	CUALQUIER PUNTO DE CABLE EN CONTROL	1	220V
100036	CUALQUIER PUNTO DE CABLE EN CABLE	1	220V
100037	CUALQUIER PUNTO DE CABLE EN CABLE	1	220V
100038	CUALQUIER PUNTO DE CABLE EN CABLE	1	220V
100039	CUALQUIER PUNTO DE CABLE EN CABLE	1	220V
100040	CUALQUIER PUNTO DE CABLE EN CABLE	1	220V
100041	CUALQUIER PUNTO DE CABLE EN CABLE	1	220V
100042	CUALQUIER PUNTO DE CABLE EN CABLE	1	220V
100043	CUALQUIER PUNTO DE CABLE EN CABLE	1	220V
100044	CUALQUIER PUNTO DE CABLE EN CABLE	1	220V
100045	CUALQUIER PUNTO DE CABLE EN CABLE	1	220V
100046	CUALQUIER PUNTO DE CABLE EN CABLE	1	220V
100047	CUALQUIER PUNTO DE CABLE EN CABLE	1	220V
100048	CUALQUIER PUNTO DE CABLE EN CABLE	1	220V
100049	CUALQUIER PUNTO DE CABLE EN CABLE	1	220V
100050	CUALQUIER PUNTO DE CABLE EN CABLE	1	220V

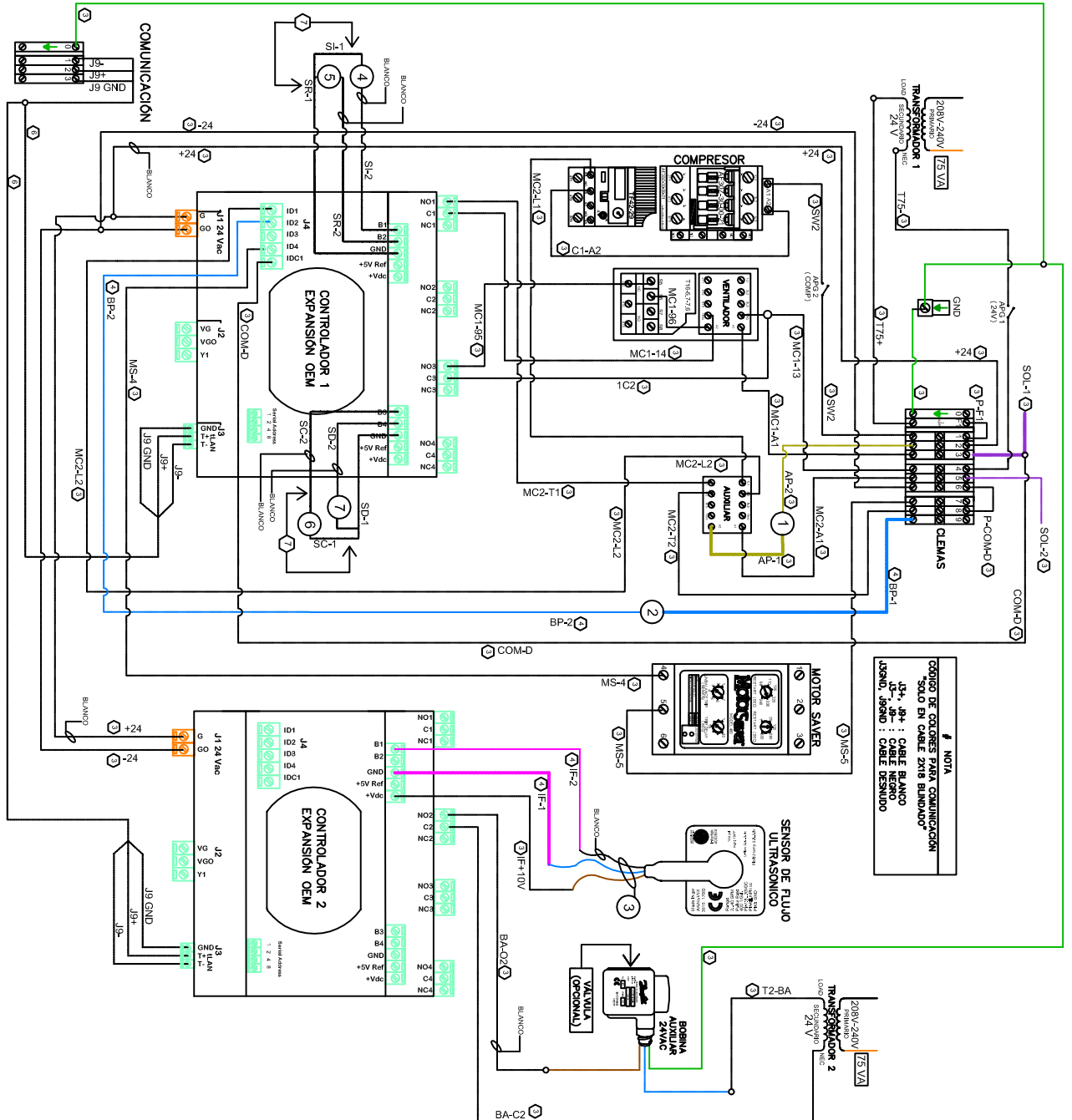

NOTA
 CODIGO DE COLORES PARA COMUNICACION
 "SOLO EN CABLE 2X18 BUNDADO"
 13- : CABLE BLANCO
 15- : CABLE NEGRO
 19- : CABLE ROJO
 19- : CABLE VERDE

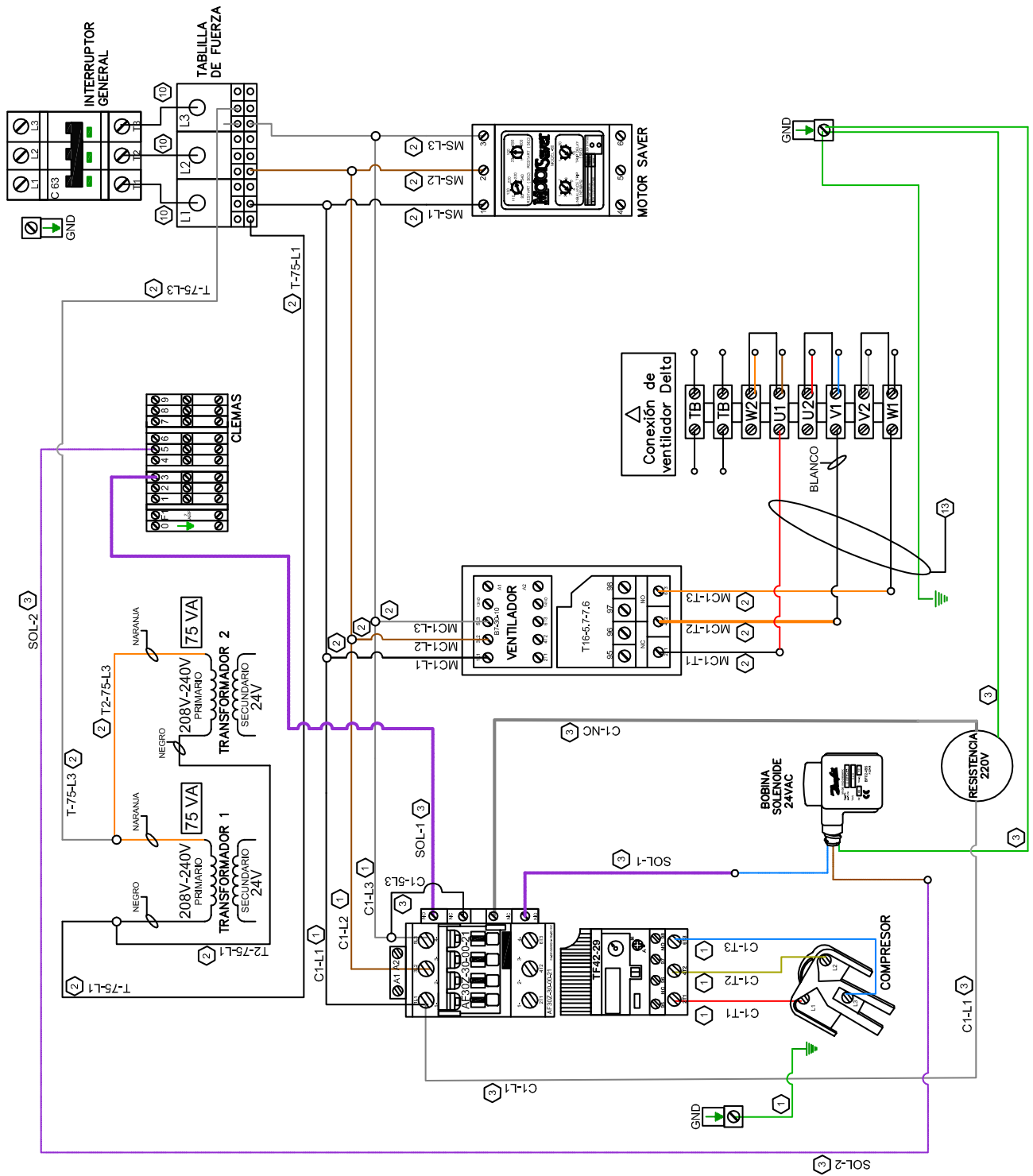

ELECTRICAL DATA

Figure 21. Typical field wiring diagram of 440v master cool only unit (single point connection with all options shown)

#	SIMBOLOGIA
	CONCEPTO
1	SENSOR DE ALTA PRESION
2	START DRIVE COMPRESOR
3	SENSOR DE FLUJO
4	SENSOR DE BAJA PRESION
5	SENSOR DE INYECCION
6	SENSOR RETORNO
7	SENSOR DE CONGELAMIENTO
8	VOLTAJE DE CONTROL
9	SENSOR SD
10	SENSOR INYECCION GENERAL (optional)
11	SENSOR RETORNO GENERAL (optional)
	# TIPO DE COLOR DE CABLE
	LINEA RAYADA
	LINEA SOLIDA
#	ESPECIFICACION DE CALIBRE DE CABLE
0	CABLE CALIBRE 3 X 8 AWG BLINDADO
1	CABLE CALIBRE 8 AWG
2	CABLE CALIBRE 14 AWG
3	CABLE CALIBRE 16 AWG
4	CABLE CALIBRE 18 AWG
5	CABLE CALIBRE 3 X 18 AWG BLINDADO
6	CABLE CALIBRE 2 X 18 AWG BLINDADO
7	CABLE CALIBRE 2 X 22 AWG BLINDADO
8	CABLE CALIBRE 4 AWG
9	CABLE CALIBRE 2 AWG
10	CABLE CALIBRE 6 AWG
11	CABLE CALIBRE 10 AWG
#	TIPO DE SENAL
	ALTO VOLTAJE
	VOLTAJE "CLASE"
	SEÑAL DE RESISTENCIA
	SEÑAL DIGITAL

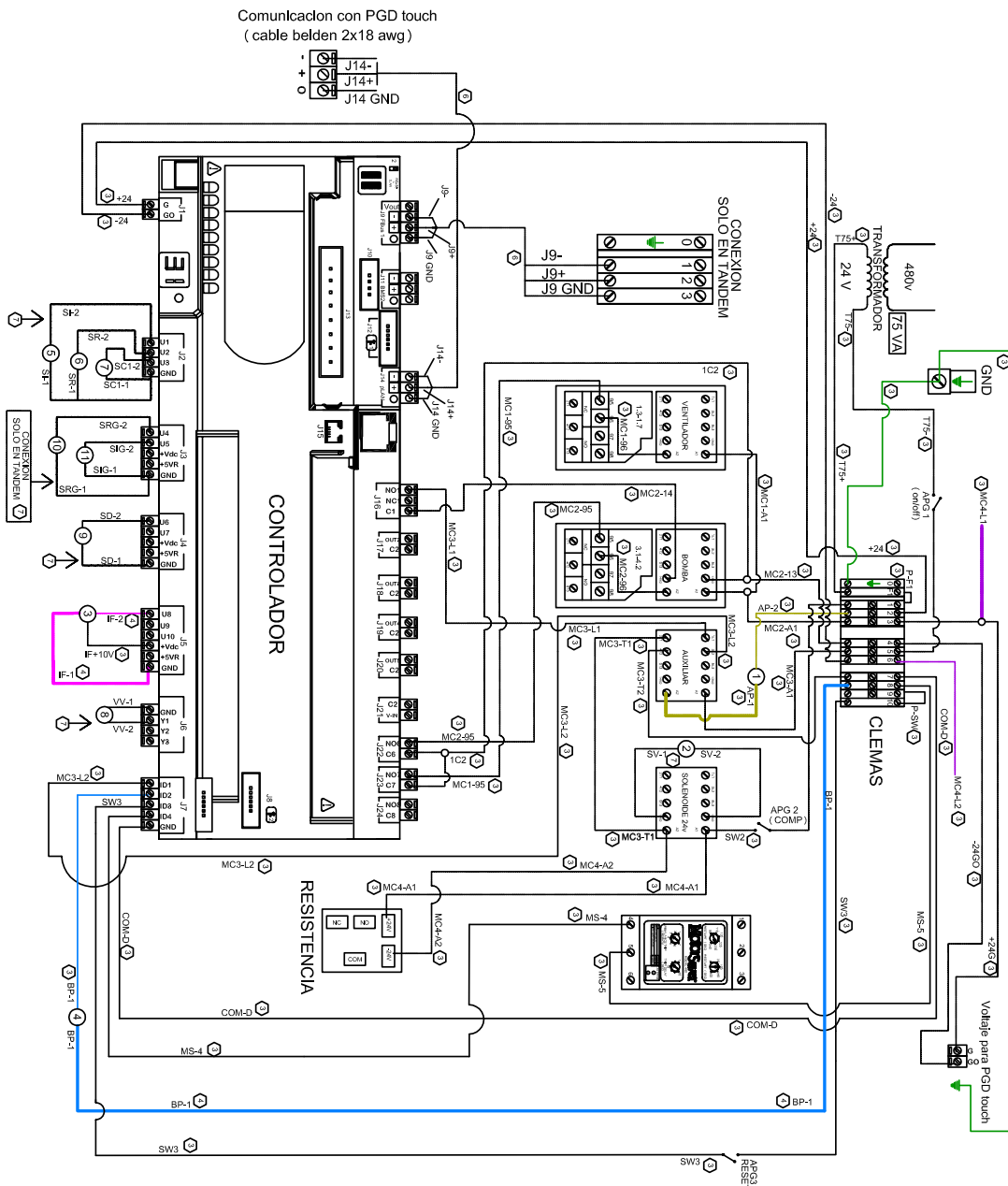

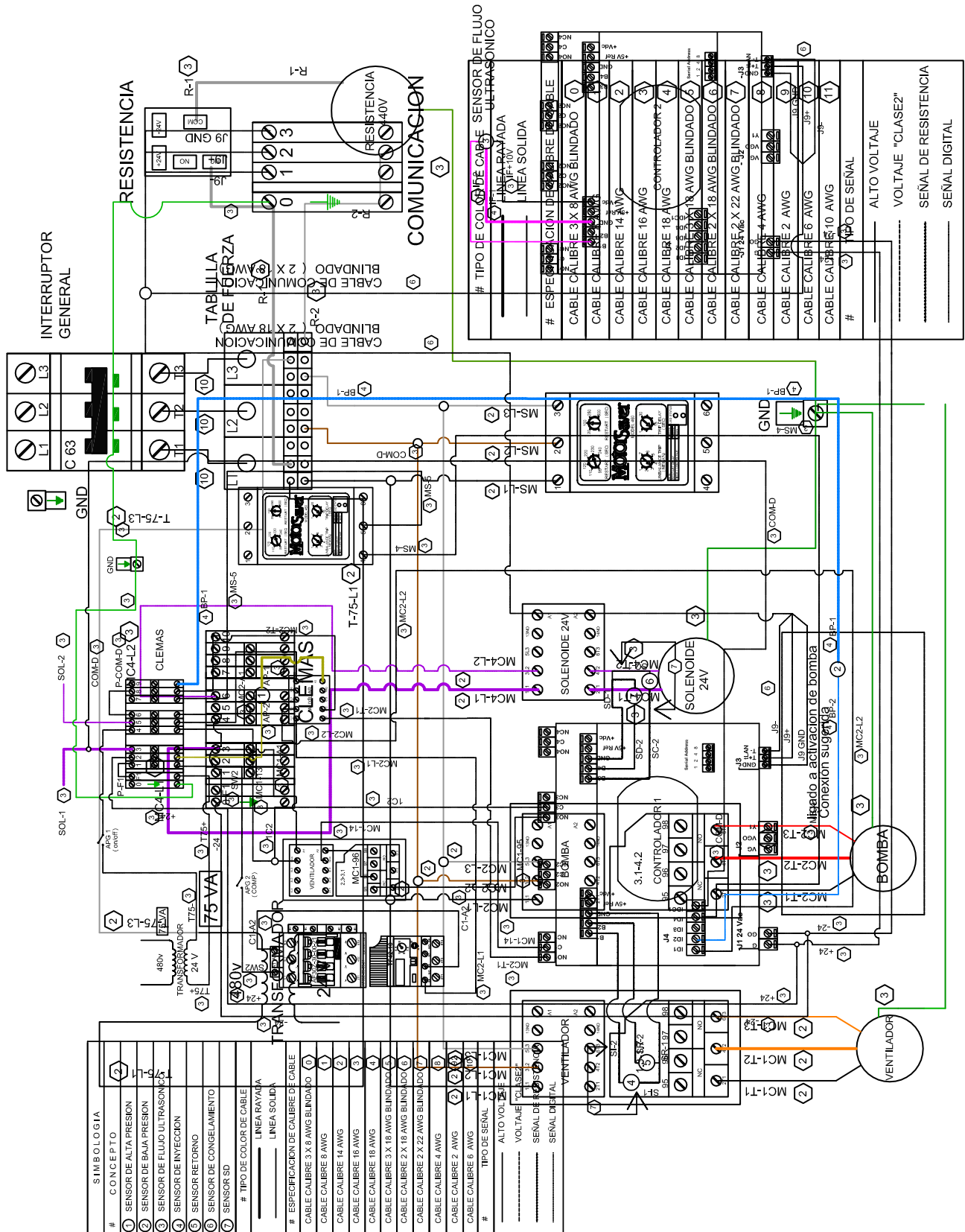

SIMBOLOGIA	
#	CONCEPTO
①	SENSOR DE ALTA PRESION
②	SENSOR DE BAJA PRESION
③	SENSOR DE FLUJO ULTRASONICO
④	SENSOR DE INYECCION
⑤	SENSOR DE RETORNO
⑥	SENSOR DE CONGELAMIENTO
⑦	SENSOR SD
# TIPO DE COLOR DE CABLE	
—	LINEA RAYADA
—	LINEA SOLIDA
# ESPECIFICACION DE CABLE DE CABLE	
①	CABLE CALIBRE 3 X 8 AWG BLINDADO
②	CABLE CALIBRE 8 AWG
③	CABLE CALIBRE 14 AWG
④	CABLE CALIBRE 16 AWG
⑤	CABLE CALIBRE 3 X 18 AWG BLINDADO
⑥	CABLE CALIBRE 2 X 18 AWG BLINDADO
⑦	CABLE CALIBRE 2 X 22 AWG BLINDADO
⑧	CABLE CALIBRE 4 AWG
⑨	CABLE CALIBRE 2 AWG
⑩	CABLE CALIBRE 6 AWG
⑪	CABLE CALIBRE 10 AWG
# TIPO DE SENAL	
—	ALTO VOLTAJE
—	VOLTAJE "CLASE2"
—	SENA DE RESISTENCIA
—	SENA DIGITAL

#	TIPO DE CABLE	SENSOR DE FLUJO ULTRASONICO
①	LINEA RAYADA	
②	LINEA SOLIDA	
# ESPECIFICACION DE CABLE		
①	CABLE CALIBRE 3 X 8 AWG BLINDADO	
②	CABLE CALIBRE 8 AWG	
③	CABLE CALIBRE 14 AWG	
④	CABLE CALIBRE 16 AWG	
⑤	CABLE CALIBRE 18 AWG	
⑥	CABLE CALIBRE 2 X 18 AWG BLINDADO	
⑦	CABLE CALIBRE 2 X 22 AWG BLINDADO	
⑧	CABLE CALIBRE 4 AWG	
⑨	CABLE CALIBRE 2 AWG	
⑩	CABLE CALIBRE 6 AWG	
⑪	CABLE CALIBRE 10 AWG	
# TIPO DE SENAL		
—	ALTO VOLTAJE	
—	VOLTAJE "CLASE2"	
—	SENA DE RESISTENCIA	
—	SENA DIGITAL	

ELECTRICAL DATA

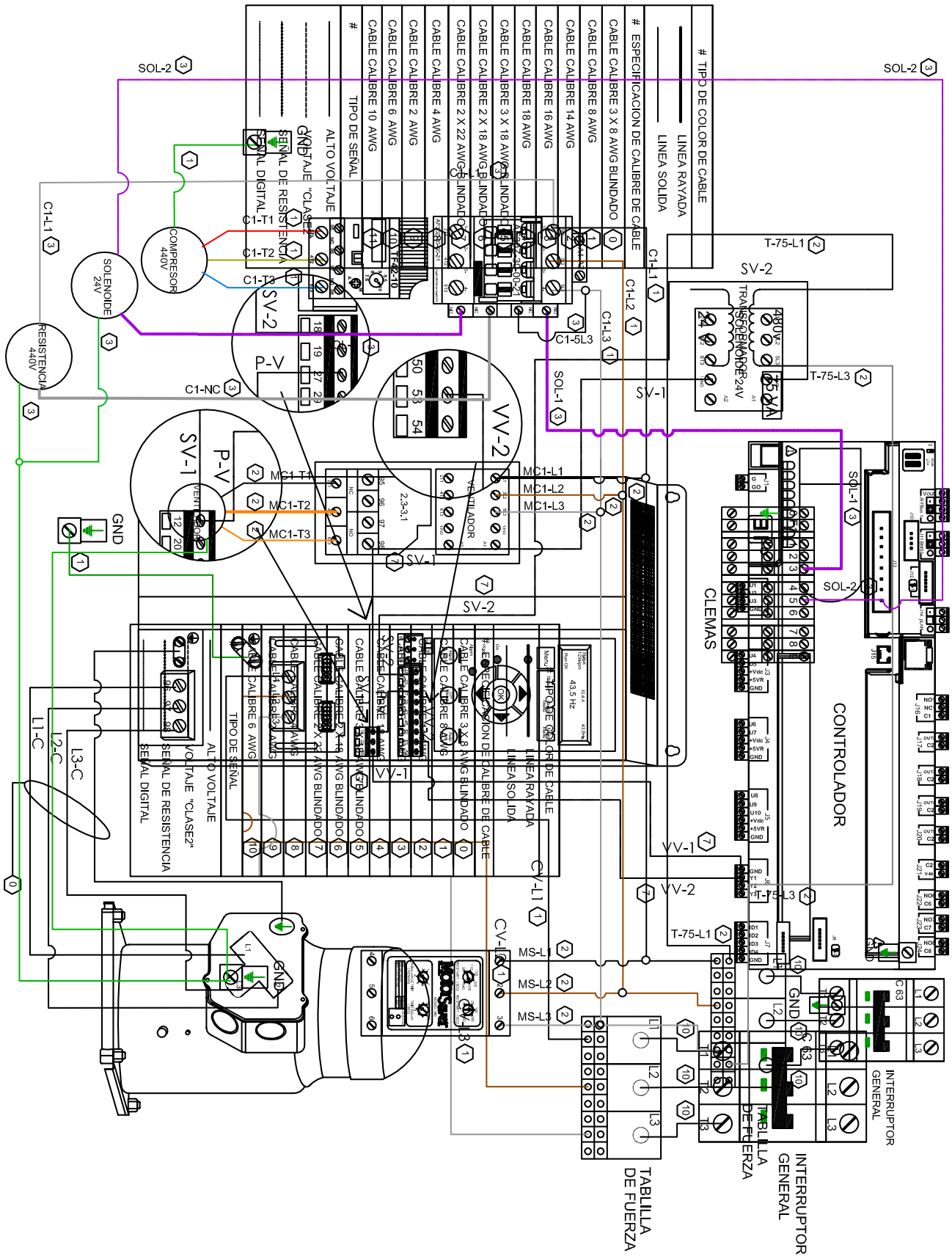
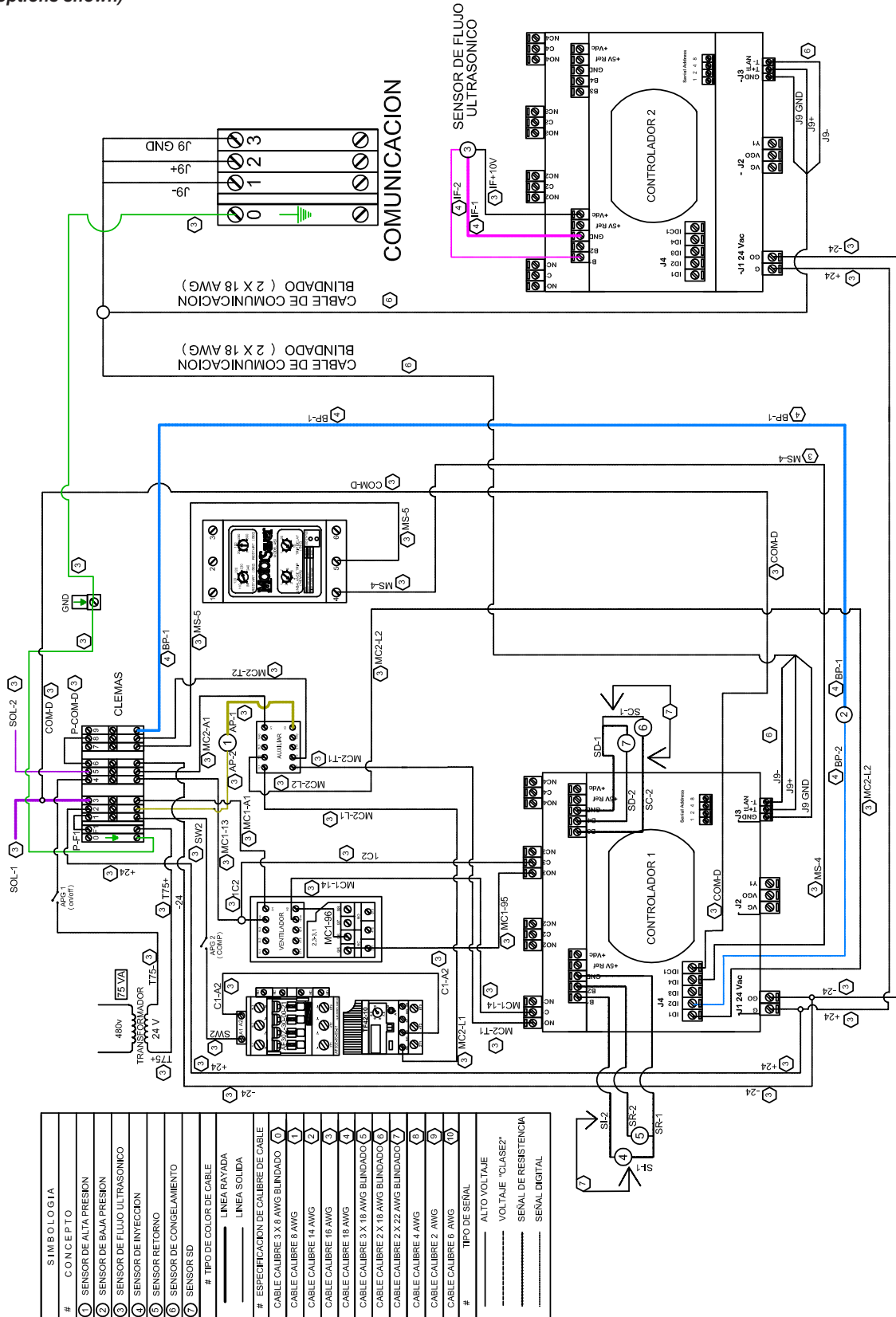
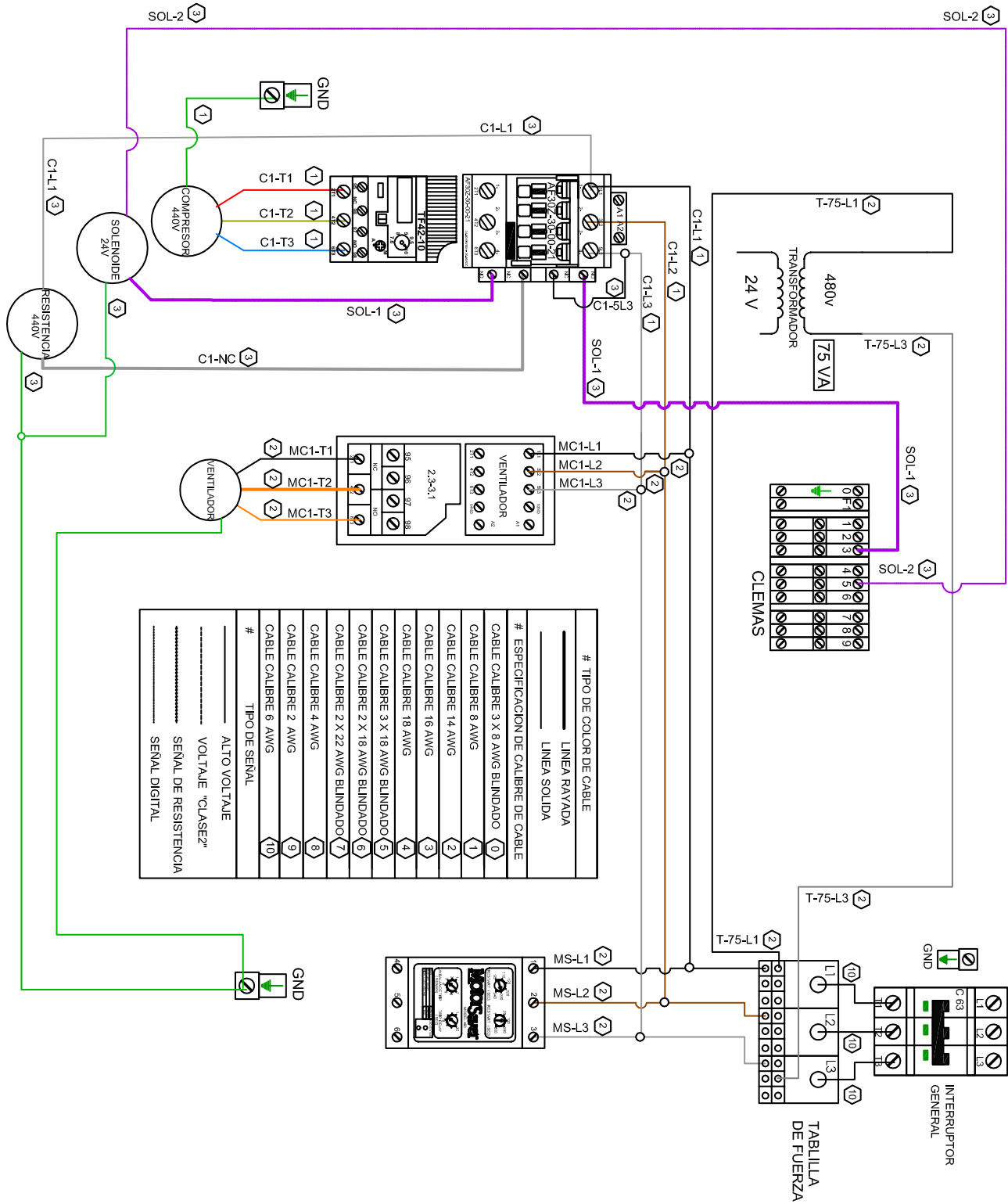

Figure 22. Typical field wiring diagram of the 440v slave single cold unit (single point connection with all options shown)



SIMBOLOGIA	
#	CONCEPTO
①	SENSOR DE ALTA PRESION
②	SENSOR DE BAJA PRESION
③	SENSOR DE FLUJO ULTRASONICO
④	SENSOR DE INYECCION
⑤	SENSOR DE RETORNO
⑥	SENSOR DE CONGELAMIENTO
⑦	SENSOR SD
# TIPO DE COLOR DE CABLE	
—	LINEA RAYADA
—	LINEA SOLIDA
# ESPECIFICACION DE CABLE DE CABLE	
①	CABLE CALIBRE 3 X 8 AWG BLINDADO
②	CABLE CALIBRE 8 AWG
③	CABLE CALIBRE 14 AWG
④	CABLE CALIBRE 16 AWG
⑤	CABLE CALIBRE 18 AWG
⑥	CABLE CALIBRE 3 X 18 AWG BLINDADO
⑦	CABLE CALIBRE 2 X 22 AWG BLINDADO
⑧	CABLE CALIBRE 4 AWG
⑨	CABLE CALIBRE 2 AWG
⑩	CABLE CALIBRE 6 AWG
# TIPO DE SENAL	
—	ALTO VOLTAJE
---	VOLTAJE "CLASE2"
-----	SENALE DE RESISTENCIA
.....	SENALE DIGITAL

ELECTRICAL DATA



GENERAL DESCRIPTION

The pCOOEM+ is an electronically programmable microprocessor-based controller that is fully compatible (software and hardware) with the pCO family of products and systems that include programmable controllers, user terminals, gateways, communication devices and remote device management. These devices represent a powerful control system that can be easily linked with the vast majority of Building Management Systems (BSM) available on the market.

The controller's menu can be accessed from a touch screen that has all the parameters and the operating status of the equipment. The pCOOEM+ continuously performs pre-failure scans of the equipment status to prevent damage to parts and components if a failure occurs.

The controller menu contains different screens and submenus that provide the operator or service technician with a complete overview of:

- 1.- User.
- 2.- Maintenance.

Figure 23. System Architecture

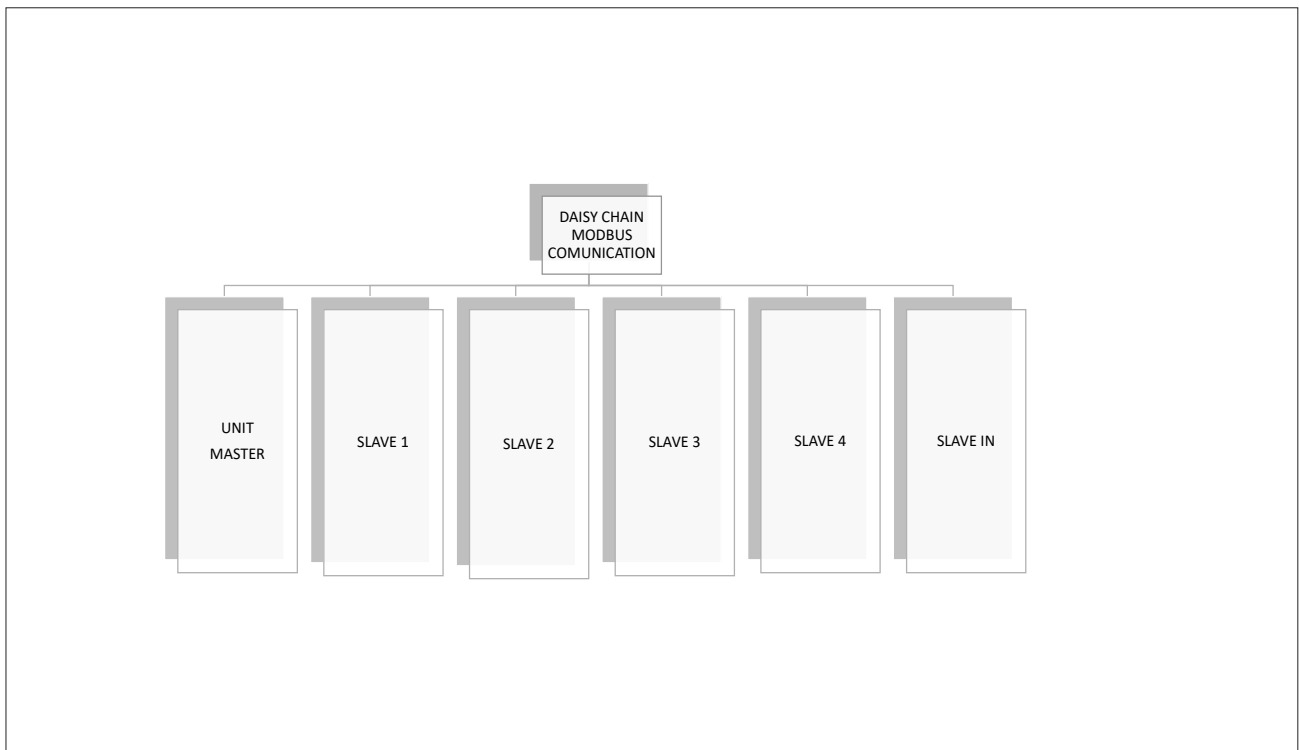

SYSTEM ARCHITECTURE

The general architecture of the controls uses the following:

- A pCOOEM+ unit controller.
- I/O extension modules as required based on the unit configuration.
- Communications interface slave modules.
- The units in the architecture have a configuration based on a MASTER unit and unit I/O slaves, these slaves can be connected via rs485 serial Modbus and can be configured from the configuration screen.

All I/O slave modules can be connected directly or via a wiring harness.

The connection order of the slaves can be from left to right or from right to left, always respecting the master as the main unit.

UNIT CONTROLLER OPERATION

INPUTS AND OUTPUTS

The configuration of the inputs and outputs depends on the initial configuration of the system.

The tables in this section show the inputs and outputs assigned to each type of configuration as well as the port used for the “Mother” unit (whose capacity is regulated by an inverter or an unloader) and the “Child” units.

Key: CO is for Cooling only and HP is for Heat Pump.

Figure 24. Analog inputs of the pCo (Mother Unit)

PORT	CO AIR	HP AIR	CO WATER	HP WATER	TIPO
U1	INJECTION	INJECTION	INYECCIÓN	INJECTION	NTC
U2	RETURN	RETURN	RETORNO	RETURN	NTC
U3	FREEZING	FREEZING	CONGELACIÓN	FREEZING	NTC
U4	MAIN RETURN	MAIN RETURN	RETORNO PRINCIPAL	MAIN RETURN	NTC
U5	MAIN INJECTION	MAIN INJECTION	INYECCIÓN PRINCIPAL	MAIN INJECTION	NTC
U6	TEM. COND	TEM. COND	INYECCIÓN DEL COND.	COND. INJECTION	NTC
U7	-	-	-	COND. RETURN	NTC

Figure 25. Digital inputs of the pCo (Mother Unit)

PORT	CO AIR	HP AIR	CO WATER	HP WATER
U9	-	SELECTOR	-	SELECTOR
ID1	HIGH PRESSURE	HIGH PRESSURE	HIGH PRESSURE	HIGH PRESSURE
ID2	LOW PRESSURE	LOW PRESSURE	LOW PRESSURE	LOW PRESSURE
ID3	REMOTE START	REMOTE START	REMOTE START	REMOTE START
ID4	MOTOR SAVER	MOTOR SAVER	MOTOR SAVER	MOTOR SAVER

Figure 26. Analog inputs of pCo 0.5-3.5 Vdc (Mother Unit)

PORT	CO AIR	HP AIR	CO WATER	HP WATER
U8	EVAPORATOR FLOW	EVAPORATOR FLOW.	EVAPORATOR FLOW	EVAPORATOR FLOW
U8	-	-	COND. FLOW	COND. FLOW
NO7	SECOND STAGE	SECOND STAGE	-	-
NO8	-	REVERSIBLE VALVE	-	-

Figure 27. Digital outputs of the pCo (Mother Unit)

PORT	CO AIR	HP AIR	CO WATER	HP WATER
NO1	COMPRESSOR	COMPRESSOR	COMPRESSOR	COMPRESSOR
NO6	PUMP	PUMP	PUMP	PUMP
NO7	FAN	FAN	-	-
NO8	-	REVERSIBLE VALVE	-	REVERSIBLE VALVE

Figure 28. Analog outputs of the pCo (Mother Unit)

PORT	CO AIR	HP AIR	CO WATER	HP WATER	TYPE
Y1	INVERTER/SSR	INVERTER/SSR	INVERTER/SSR	INVERTER/SSR	0-10 V
Y2	INVERTER FAN	INVERTER FAN	INVERTER FAN	INVERTER FAN	0-10 V

Figure 29. Analog inputs of the pCo (Expansion Module Son)

PORT	CO AIR	HP AIR	CO WATER	HP WATER	TYPE
B1	INJECTION	INJECTION	INJECTION	INJECTION	NTC
B2	RETURN	RETURN	RETURN	RETURN	NTC
B3	FREEZING	FREEZING	FREEZING	FREEZING	NTC
B4	CONDENSER	CONDENSER	COND. INJECTION	COND INJECTION	NTC

Figure 30. Analog inputs of the pCo (Auxiliary Child Expansion Module)

PORT	CO AIR	HP AIR	CO WATER	HP WATER	TYPE
B1	EVAPORATOR FLOW	EVAPORATOR FLOW	EVAPORATOR FLOW	EVAPORATOR FLOW	5-3.5 VCD
B2	CONDENSER FLOW	CONDENSER FLOW	CONDENSER FLOW	CONDENSER FLOW	5-3.5 VCD
B3	CONDENSER RETURN	CONDENSER RETURN	CONDENSER RETURN	CONDENSER RETURN	NTC
DI4	SAVER MOTOR	SAVER MOTOR	-	-	

Figure 31. Digital inputs of the pCo (Expansion Module Son)

PORT	CO AIR	HP AIR	CO WATER	HP WATER
DI1	HIGH PRESSURE	HIGH PRESSURE	HIGH PRESSURE	HIGH PRESSURE
DI2	LOW PRESSURE	LOW PRESSURE	LOW PRESSURE	LOW PRESSURE
DI3	EVAPORATION FLOW	EVAPORATION FLOW	EVAPORATION FLOW	EVAPORATION FLOW
DI4	*ENGINE SAVER	*ENGINE SAVER	*MOTOR SAVER	*MOTOR SAVER

NOTES: Digital motor protector inputs on “Daughter” units are optional and their consideration depends on the initial configuration of the system, on the other hand motor protection input on “Mother” units is indispensable.

NOTES: The digital output pump in “Child” units depends on the initial system configuration. It is not possible to use it if the system is configured with only one “Mother” pump (pCO unit).

Figure 32. Digital outputs of the pCo (Expansion Module Son)

PORT	CO AIR	HP AIR	CO WATER	HP WATER
NO1	COMPRESSOR	COMPRESSOR	COMPRESSOR	COMPRESSOR
NO2	**PUMP	**PUMP	**PUMP	**PUMP
NO3	FAN	FAN	FAN	FAN
NO4		REVERSIBLE VALVE	-	REVERSIBLE VALVE

UNIT CONTROLLER OPERATION

SET POINTS

When we start configuring the unit for the first time all the preload parameters have a default value, these values are stored in permanent memory but can be changed depending on the application of the unit.

The values can be changed from the display and the submenus require a password if you want to change the values; if an option is not included in the display menu the data is only an internal value in the controller and will be visible only if that mode is selected.

The table below has a description of each default set point and can be set to any value in the range column.

Table 6. Default Values and Unit Level Setpoint Ranges

DESCRIPTION	DEFAULT	RANGE
INSTALLATION OF THE MAIN SCREEN		
TYPE OF MACHINE	AIR-WATER	WATER, AIR-WATER
MACHINE TYPE	CHILLER	CHILLER, HEAT PUMP
CAPACITY	INVERTER	PWM, INVERTER
NUMBER OF SLAVES	NONE	NONE, ONE, TWO, THREE, FOUR, FIVE, SIX, SEVEN, EIGHT, NINE, TEN
DATE	CURRENT DATE	30 DAYS
MONTH	CURRENT MONTH	12 MONTHS
YEAR	CURRENT YEAR	9999 YEARS
USER MENU SCREEN		
CLOCK		ACCESS
WORKING WORK		ACCESS
SYNOPTIC		ACCESS
CHILLER/HP		ACCESS
PROGRAMMING		ACCESS
REGULATION		ACCESS
ACCESS		ACCESS
LANGUAGE AND MAINTENANCE SCREEN		
LANGUAGE	ENGLISH	ENGLISH, SPANISH
CLOCK SCREEN		
DATE	CURRENT DATE	30 DAYS
MONTH	CURRENT MONTH	12 MONTHS
YEAR	CURRENT YEAR	9999 YEARS
WORKING HOURS DISPLAY(1)		
TOTAL STARTS		
COMP.M	0	0 a 999
COMP.E1	0	0 a 999
COMP.E2	0	0 a 999

COMP.E3	0	0 a 999
COMP.E4	0	0 a 999
COMP.E5	0	0 a 999
COMP.E6	0	0 a 999
COMP.E7	0	0 a 999
TOTAL STARTS PER HOUR		
COMP.M	0	0 a 999
COMP.E1	0	0 a 999
COMP.E2	0	0 a 999
COMP.E3	0	0 a 999
COMP.E4	0	0 a 999
COMP.E5	0	0 a 999
COMP.E6	0	0 a 999
COMP.E7	0	0 a 999
HIGH PRESSURE METER (AP)		
COMP.M	0	0 a 999
COMP.E1	0	0 a 999
COMP.E2	0	0 a 999
COMP.E3	0	0 a 999
COMP.E4	0	0 a 999
COMP.E5	0	0 a 999
COMP.E6	0	0 a 999
COMP.E7	0	0 a 999
LOW PRESSURE (BP) METER		
COMP.M	0	0 a 999
COMP.E1	0	0 a 999
COMP.E2	0	0 to 999
COMP.E3	0	0 to 999
COMP.E4	0	0 to 999
COMP.E5	0	0 to 999
COMP.E6	0	0 to 999
COMP.E7	0	0 to 999
FROZEN WATER (AH)		
COMP.M	0	0 to 999
COMP.E1	0	0 to 999
COMP.E2	0	0 to 999
COMP.E3	0	0 to 999
COMP.E4	0	0 to 999
COMP.E5	0	0 to 999

UNIT CONTROLLER OPERATION

COMP.E6	0	0 to 999
COMP.E7	0	0 to 999
FREEZING (FREEZING)		
COMP.M	0	0 to 999
COMP.E1	0	0 to 999
COMP.E2	0	0 to 999
COMP.E3	0	0 to 999
COMP.E4	0	0 to 999
COMP.E5	0	0 to 999
COMP.E6	0	0 to 999
COMP.E7	0	0 to 999
SYNOPTIC DISPLAY (2)		
TOTAL START-UPS		
COMP.M	0	0 to 999
COMP.E1	0	0 to 999
COMP.E2	0	0 to 999
COMP.E3	0	0 to 999
COMP.E4	0	0 to 999
COMP.E5	0	0 to 999
COMP.E6	0	0 to 999
COMP.E7	0	0 to 999
TOTAL START-UPS PER HOUR		
COMP.M	0	0 to 999
COMP.E1	0	0 to 999
COMP.E2	0	0 to 999
COMP.E3	0	0 to 999
COMP.E4	0	0 to 999
COMP.E5	0	0 to 999
COMP.E6	0	0 to 999
COMP.E7	0	0 to 999
HIGH PRESSURE METER (AP)		
COMP.M	0	0 to 999
COMP.E1	0	0 to 999
COMP.E2	0	0 to 999
COMP.E3	0	0 to 999
COMP.E4	0	0 to 999
COMP.E5	0	0 to 999
COMP.E6	0	0 to 999
COMP.E7	0	0 to 999

LOW PRESSURE (BP) METER		
COMP.M	0	0 to 999
COMP.E1	0	0 to 999
COMP.E2	0	0 to 999
COMP.E3	0	0 to 999
COMP.E4	0	0 to 999
COMP.E5	0	0 to 999
COMP.E6	0	0 to 999
COMP.E7	0	0 to 999

COLD WATER (AH)		
COMP.M	0	0 to 999
COMP.E1	0	0 to 999
COMP.E2	0	0 to 999
COMP.E3	0	0 to 999
COMP.E4	0	0 to 999
COMP.E5	0	0 to 999
COMP.E6	0	0 to 999
COMP.E7	0	0 to 999

FREEZING		
COMP.M	0	0 to 999
COMP.E1	0	0 to 999
COMP.E2	0	0 to 999
COMP.E3	0	0 to 999
COMP.E4	0	0 to 999
COMP.E5	0	0 to 999
COMP.E6	0	0 to 999
COMP.E7	0	0 to 999

RUNTIME WORK SCREEN(3)		
TOTAL STARTS		
BOMBA E5	0	0 to 999
BOMBA E6	0	0 to 999
BOMBA E7	0	0 to 999
TRABAJO EN TIEMPO REAL		
BOMBA E5	0	0 to 999
BOMBA E6	0	0 to 999
BOMBA E7	0	0 to 999

OVERVIEW SCREEN		
-----------------	--	--

SEQUENCE OF OPERATION

Figure 33. Sequence of operation of the unit - Cool mode

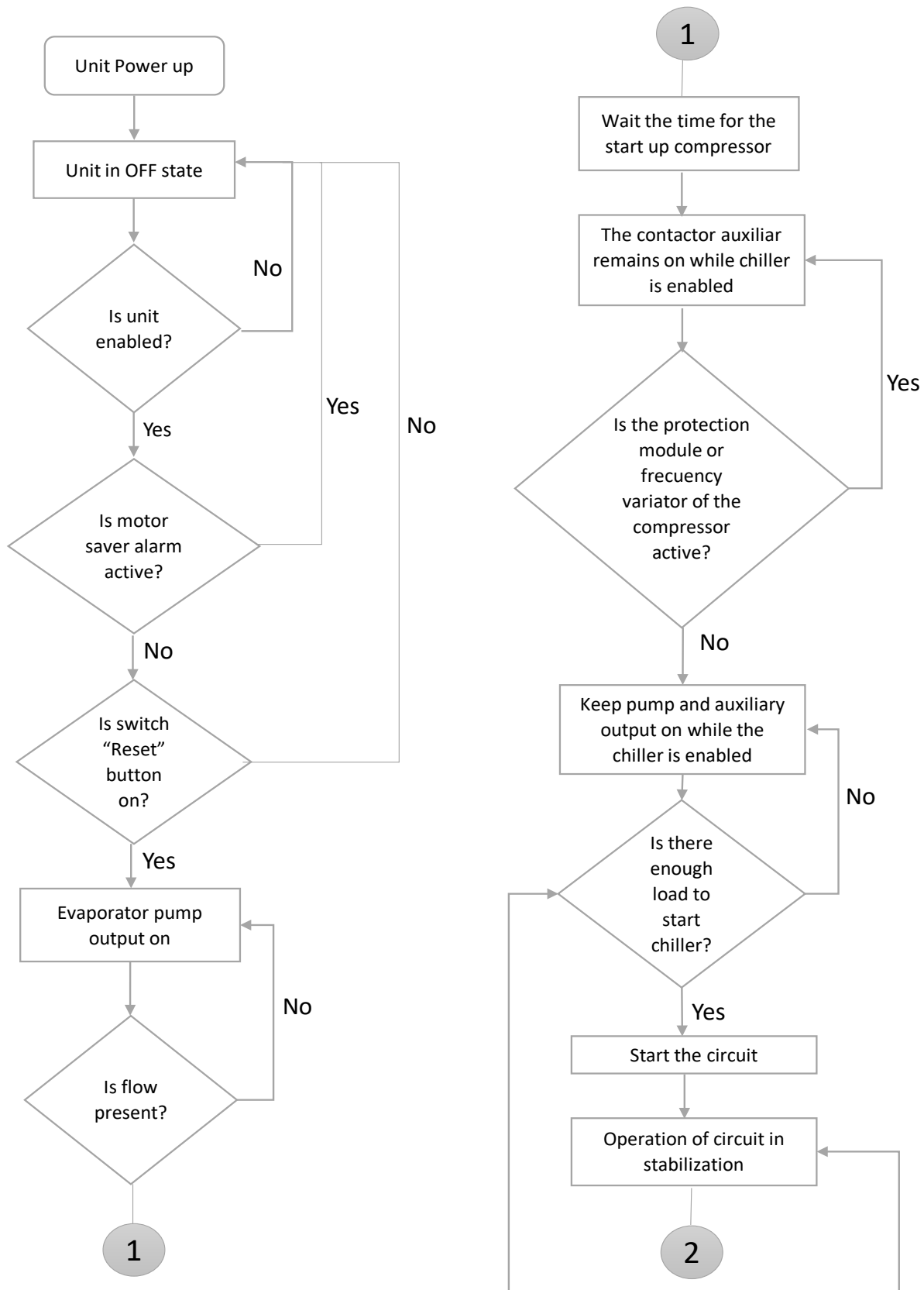

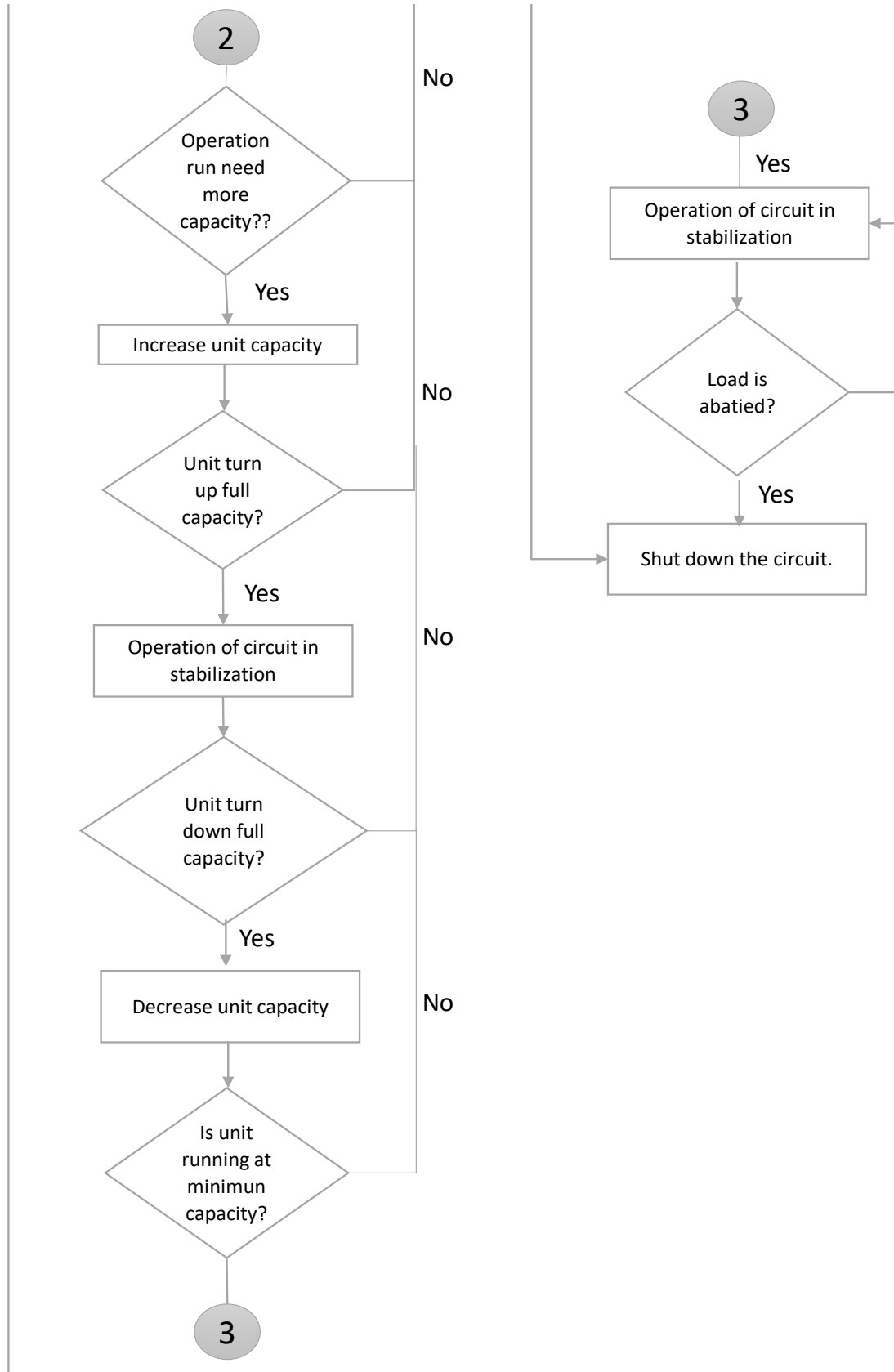

SEQUENCE OF OPERATION

Figure 34. Sequence of operation of the unit - heat pump mode

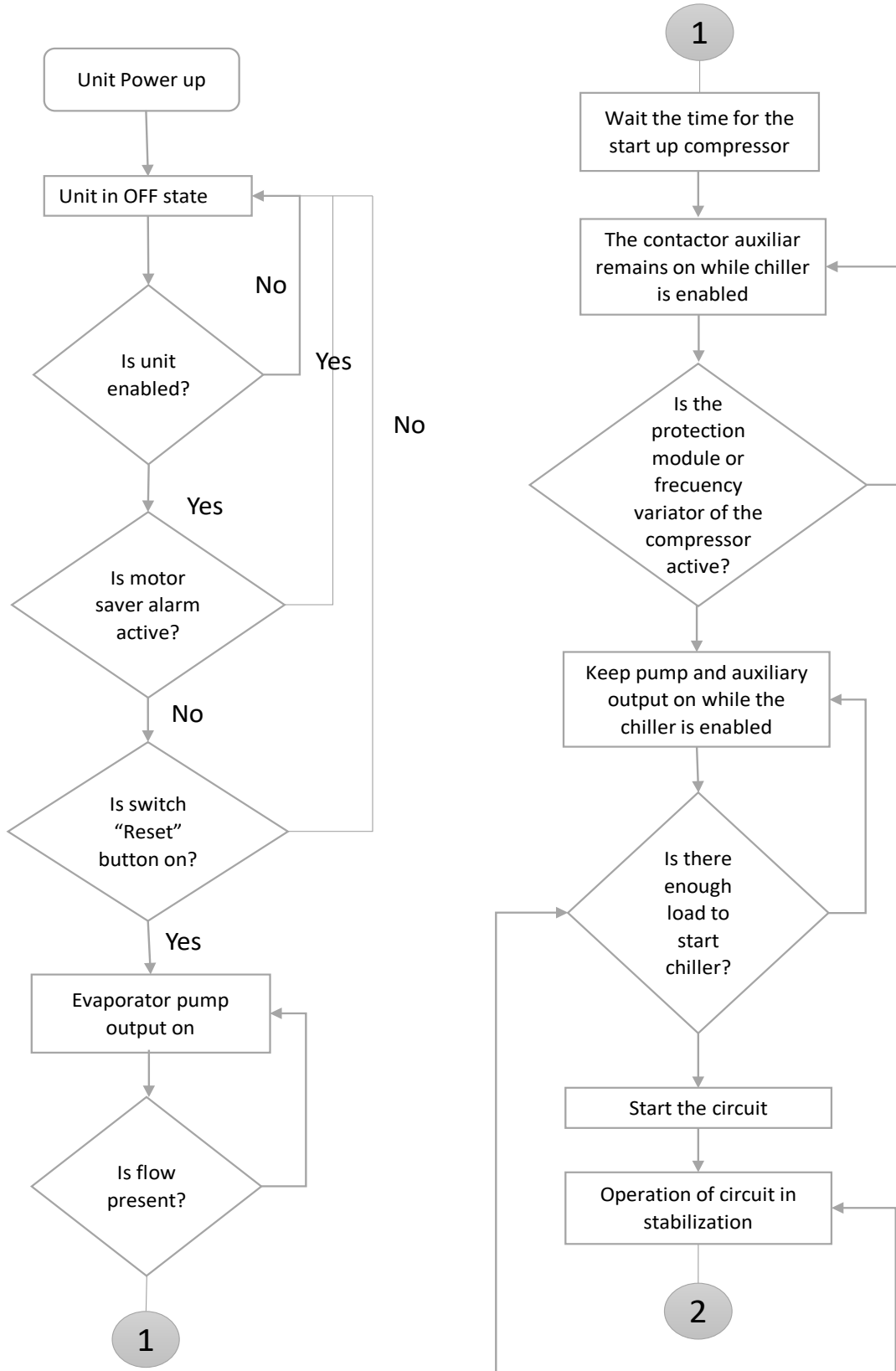

SEQUENCE OF OPERATION

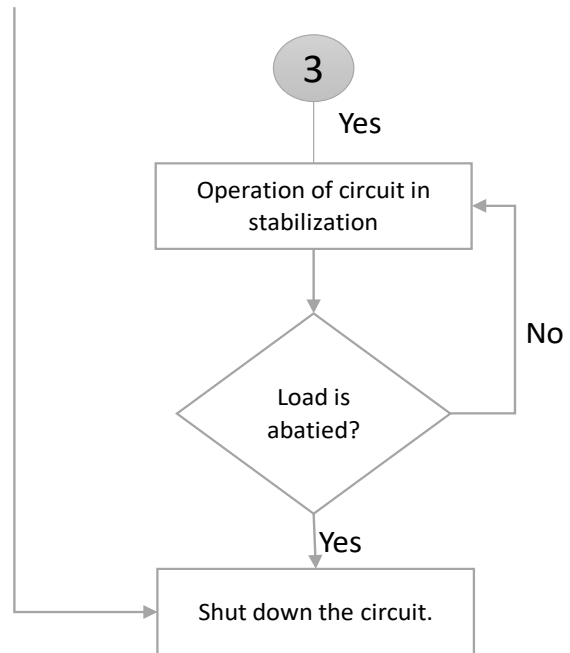
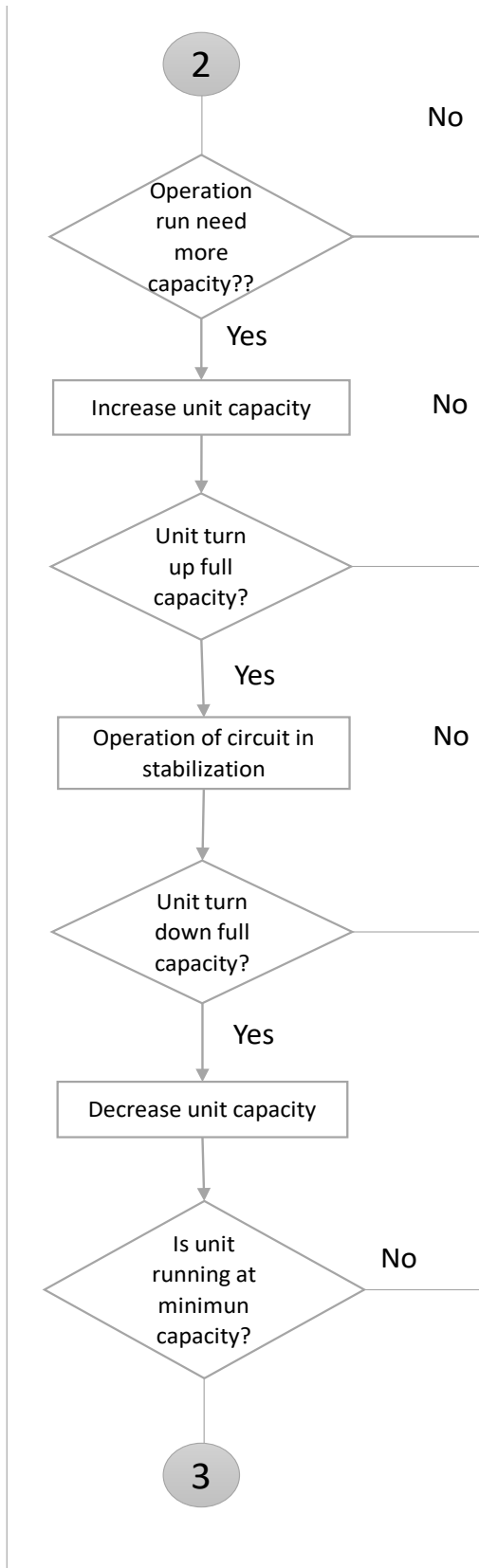

UNIT FUNCTIONS

The calculations in this section are used in unit-level control logic or all-circuit control logic.

EVAPORATOR DELTA T

The Delta T of the evaporator water is calculated as the temperature of the water entering minus that leaving through all circuits.

PENDING LWT

The slope of LWT is calculated such that the slope represents the estimated change in LWT is immediately.

RATE OF DECLINE

The slope value calculated above will be a negative value as the water temperature is dropping. The rate of descent is calculated by pouring the slope value and imitating it at a minimum value of 4°C/sec.

LWT ERROR

The LWT error is calculated as LWT - target LWT.

UNIT CAPACITY

Unit capacity is the Delta T of the unit operating for GPM of water.

Table 7. Minimum flow rates and corresponding maximum effective Delta T capacity with variable flow rate.

TR	"Number of compressors"	Capacity Unit	"Nominal Nominal (Nominal %)"	"Maximum effective full (°F) Capacity DT"
5	1	100%	100%	10.0
7.5	2	100%	96%	10.5
10	3	100%	92%	10.9
12.5	4	100%	88%	11.3
20	5	100%	85%	11.8
30	6	100%	81%	12.4
40	7	100%	77%	13.0
50	8	100%	73%	13.6
62.5	9	100%	70%	14.3

CALCULATIONS BY CONTROLLER

Refrigerant saturation temperature

The saturated coolant temperature will be calculated from the pressure sensor readings for each circuit.

Evaporator approach

The evaporator approximation will be calculated for each circuit. The equation is as follows

Evaporator approximation = LWT - Evaporator saturated temperature.

Condenser approach

The capacitor approximation will be calculated for each circuit. The equation is as follows

Capacitor approximation = Capacitor saturated temperature - OAT.

Suction reheating

The suction superheat shall be calculated for each circuit using the following equation:

Suction superheat = Suction temperature - Evaporator saturated temperature.

Pumping pressure

The pressure at which a circuit will pump down is based on the low pressure set point of the evaporator. The equation is as follows

Pump down pressure = Evaporator low pressure set point - 103KPA (15 PSI)

CIRCUIT LOGIC CONTROL

Circuit enablement

A circuit must be enabled to start if the following conditions are met:

- Circuit breaker is closed
- No circuit alarms are active
- Circuit mode setpoint is set to Enable
- At least one compressor is enabled to start (according to enable setpoints)

COMPRESSOR AVAILABILITY

A compressor is considered to be available to start if all of the following are met:

- The corresponding circuit is enabled.
- The corresponding circuit is not in pumping stop.
- No cycle timers are active for the compressor.
- The corresponding circuit is not in pump-down stop state -No cycle timers are active for the compressor.
- Compressor is enabled through the enable set points.
- Compressor is not running.

CIRCUIT STATUS

The circuit will always be in one of four states:

Off - The circuit is not running.

Preopen - The circuit is preparing to start Running - The circuit is running

Pump off - The circuit is performing a normal shutdown.

The transitions between these states are shown in the following diagram.

Figure 35. Circuit states.

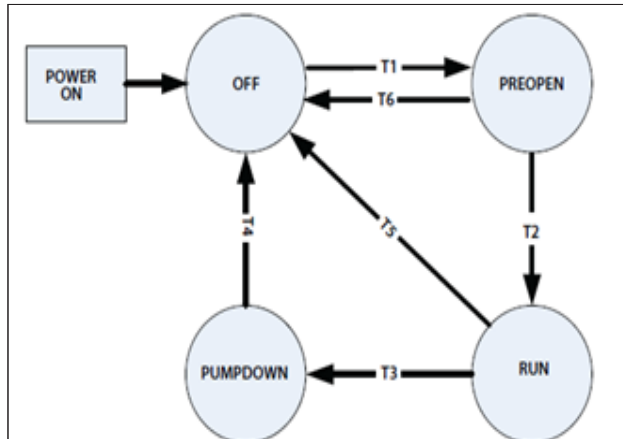

T1 - At pre-opening

- No compressor is running and any compressor in the circuit is commanded to start (see unit capacity control).

T2 - Pre-open to run

- 5 seconds have elapsed in pre-opening state

T3 - Run to pump down

Any of the following is required:

- Last compressor in the circuit is commanded to stop.
- Unit status = Pump stopped
- Circuit breaker is open
- Circuit mode is disabled
- Circuit breaker is open -Circuit mode is disabled -Pump down alarm is active

T4 - Pumping down on Off

Any of the following is required:

- Evaporator pressure < Pump downstream pressure value.
- Unit status = Off
- Unit status = Off -Quick circuit shutdown alarm is active -Evaporator pressure < Value of pump down pressure.a.

T5 - Run to Off

Any of the following is required:

- Unit status = Off
- Fast circuit shutdown alarm is active
- Low temperature start attempt failed

T6 - Pre-open to Off

Any of the following is required:

- Unit status = Off
- Unit status = Pump off
- Circuit breaker is open
- Circuit mode is deactivated
- The circuit quick stop alarm is activated.
- Pumping alarm is activated

COMPRESSOR CONTROL

Compressors should operate only when the circuit is in the operating or pumping state. They should not operate when the circuit is in any other state.

Compressor start-up

A compressor must start if it receives a start command from the unit capacity control logic.

Compressor shutdown

A compressor must be shut down if any of the following situations occur:

- The unit's capacity control logic commands it to shut down.
- A discharge alarm occurs and sequencing requires this compressor to be the next compressor to shut down.
- The circuit status is pumping and sequencing requires this compressor to be the next compressor to shut down.

CONTROLLER CALCULATIONS

A minimum time between compressor starts and a minimum time between compressor stop and compressor start will apply. The time values are determined by the start timer and stop timer set points. These cycle timers should not be applied by power cycling the chiller. This means that if the power is cut off, the cycle timers should not be active. These timers can be cleared by a setting on the controller.

CONDENSER FAN CONTROL

The condenser fan control shall start the fans as required whenever the compressors are running in the circuit (Tandem). All fans and solenoid valves shall be off when the circuit is in the off and pre-open state.

The digital outputs of the condenser fans will turn on or off immediately for condenser stage changes. The outputs of the capacitor solenoid valves will turn on immediately when a step-up stage requires the output to turn on, but will have a delay to turn off during a step-down stage.

This delay is 20 seconds. If the circuit is turned off, the capacitor solenoid valve outputs will turn off without delay.

Figure 36. Fan sequence according to capacity

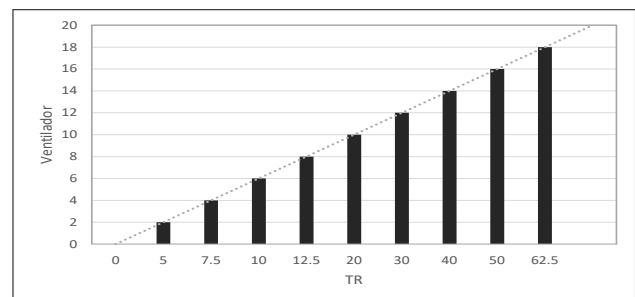

CIRCUIT FUNCTIONS

OVERHEATING CONTROL STATUS OPERATION

TXV Operation

The measurement of refrigerant flow to the evaporator is the exclusive function of a TXV. It must measure this flow at precisely the same rate at which the refrigerant is evaporated by the heat charge.

The TXV does this by maintaining the coil with enough refrigerant to maintain the correct superheat of the suction gas leaving the evaporator coil.

The TXV regulates the flow in response to the superheat of the charge.

If it is suspected that a TXV is not operating properly, checking for overheating is the only way to be sure. Do this with precision instrumentation to obtain meaningful results.

Operating overheat of 8°F to 12°F are considered normal. Here are some "tips" to help in detecting and fixing performance failures in a TXV:

- Check the bulb to make sure it is properly connected to the suction line. If you can move the bulb manually, it is not properly secured.
- The bulb must be perfectly insulated to protect it against the effects of a draft.
- Check the equalizer line for restrictions (kinks) or signs of frost. A frosted equalizer line indicates internal leakage and will require valve replacement. Repair or replacement of a bent equalizer will be necessary for the valve to operate properly.

TXVs are designed to measure liquid refrigerant flow. If the refrigerant at the valve inlet contains flash gas, the valve capacity will be reduced. Make sure that the system is properly charged and that there is some subcooling at the valve inlet before discarding the TXV.



Dimensions (Mm)

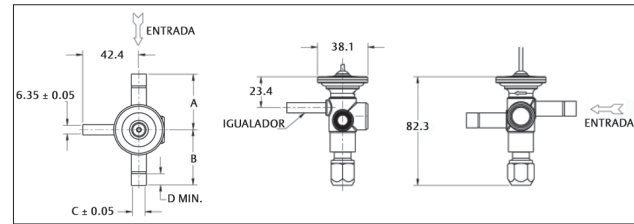

Adjustable - ODF connections with 1/4" equalizer

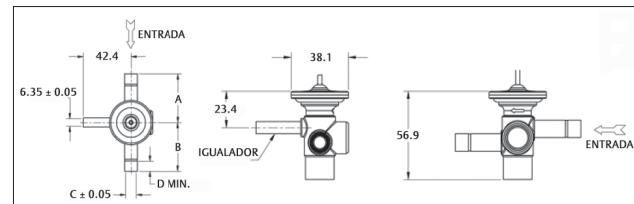

Non-adjustable - Odf connections with 1/4" equalizer

Connections	Dimensions			
	A	B	C	D
3/8 ODF	41.9	41.9	9.6 (3/8)	8.6
1/2 ODF	41.9	41.9	12.8 (1/2)	12.2
5/8 ODF	54.6	54.6	16.0 (5/8)	19.0
7/8 ODF	54.6	54.6	22.3 (7/8)	19.0
1-1/8 ODF	61.0	61.0	28.7 (1-1/8)	23.1

The alarms described below contain the on-screen description of each alarm.

MASTER ALARMS
FAILURE IN TEMPERATURE MASTER INJECTION HEAD PROBE, BROKEN OR DISCONNECTED
FAILURE IN TEMPERATURE MASTER RETURN TEMPERATURE PROBE, BROKEN OR DISCONNECTED
MOTOR SAVER ALARM
MASTER LOW PRESSURE ALARM
MASTER HIGH PRESSURE ALARM
MASTER EVAPORATOR FREEZE ALARM
MASTER CONDENSER FREEZE ALARM
MASTER CHILLED WATER CONDENSER ALARM
MASTER EVAPORATOR FLOW ALARM
MASTER CONDENSER FLOW ALARM
MASTER REFRIGERANT ALARM
MASTER INJECTION SENSOR PROBE FAILURE
MASTER RETURN SENSOR PROBE FAILURE
MASTER FREEZE PROBE FAILURE
E1 SLAVE ALARMS
E1 SAVER ENGINE ALARM
LOW PRESSURE ALARM E1
HIGH PRESSURE ALARM E1
EVAPORATOR FREEZE-UP ALARM E1
CONDENSER FREEZE ALARM E1
HIGH CHILLED WATER CONDENSER E1
EVAPORATOR FLOW ALARM E1
E1 CONDENSER FLOW ALARM E1
E1 REFRIGERANT ALARM E1
E1 INJECTION SENSOR SENSOR PROBE FAILURE E1
RETURN SENSOR SENSOR PROBE FAILURE E1
SLAVE ALARMS E2
E2 ENGINE SAVER ALARM
LOW PRESSURE ALARM E2

E2 HIGH PRESSURE ALARM
E2 EVAPORATOR FREEZE-UP ALARM
CONDENSER FREEZE-UP ALARM E2
CONDENSER HIGH CHILLED WATER CONDENSER E2
E2 EVAPORATOR FLOW ALARM
E2 CONDENSER FLOW ALARM E2
E2 REFRIGERANT ALARM E2
E2 INJECTION SENSOR SENSOR PROBE FAILURE E2
E2 RETURN SENSOR SENSOR PROBE FAILURE E2
E3 SLAVE ALARMS
E3 ENGINE SAVER ALARM
E3 LOW PRESSURE ALARM
HIGH PRESSURE ALARM E3
E3 EVAPORATOR FREEZE ALARM E3
E3 CONDENSER FREEZE ALARM
CONDENSER HIGH CHILLED WATER CONDENSER E3
E3 EVAPORATOR FLOW ALARM
E3 CONDENSER FLOW ALARM
E3 REFRIGERANT ALARM E3
E3 INJECTION SENSOR SENSOR PROBE FAILURE E3
E3 E3 RETURN SENSOR PROBE FAILURE
E4 SLAVE ALARMS
E4 ENGINE SAVER ALARM
E4 LOW PRESSURE ALARM
E4 HIGH PRESSURE ALARM
E4 EVAPORATOR FREEZE ALARM
E4 CONDENSER FREEZE ALARM
CONDENSER HIGH CHILLED WATER CONDENSER E4
E4 EVAPORATOR FLOW ALARM
E4 FLOW CONDENSER ALARM

CONTROLLER USAGE

E5 SLAVE ALARMS
E5 ENGINE SAVER ALARM
E5 LOW PRESSURE ALARM
E5 HIGH PRESSURE ALARM
E5 EVAPORATOR FREEZE ALARM
E5 CONDENSER FREEZE ALARM
CONDENSER HIGH CHILLED WATER CONDENSER E5
E5 EVAPORATOR FLOW ALARM
E5 CONDENSER FLOW ALARM
E5 REFRIGERANT ALARM
E5 INJECTION SENSOR SENSOR PROBE FAILURE
E5 RETURN SENSOR SENSOR PROBE FAILURE
E6 SLAVE ALARMS
E6 ENGINE SAVER ALARM
LOW PRESSURE ALARM E6
HIGH PRESSURE ALARM E6
EVAPORATOR FREEZE ALARM E6
E6 CONDENSER FREEZE ALARM
CONDENSER HIGH CHILLED WATER CONDENSER E6
E6 EVAPORATOR FLOW ALARM
E6 CONDENSER FLOW ALARM
E6 REFRIGERANT ALARM E6
INJECTION SENSOR PROBE FAILURE E6
E6 RETURN SENSOR SENSOR PROBE FAILURE
E7 SLAVE ALARMS
E7 ENGINE SAVER ALARM
LOW PRESSURE ALARM E7
HIGH PRESSURE ALARM E7
E7 EVAPORATOR FREEZE ALARM

GRAPHICAL USER INTERFACE

Control states

The configured devices will display this screen by default.

1. Control status button: Can be active or inactive by a digital input or inactive by the pGD Touch terminal.
2. Selection of temperature measurement type: (*1Fahrenheit or Celsius).
3. Date.
4. Time

TRENDS

The pGD Touch terminal has in memory the information about the temperature readings of the injection and return sensor of the main unit, as well as the injection and return temperatures of all enabled units. When pressing the trend button, the user will be redirected to a menu where he/she can select the type of trend to display.

In the main unit section, the injection and return readings of the main unit will be displayed. In the unit section, the injection and return sensor readings of all units will be displayed.

The trend properties that can be edited are the duration, high and low limits. These properties are editable in the navigation menu. The pGD Touch terminal saves a reading of each of the above temperatures every 180 seconds and can save more than 100,000 samples of data before starting to overwrite the old data. With these parameters the pGD Touch terminal can store data for the last 7 months.



This menu shows the current temperature in the equipment.

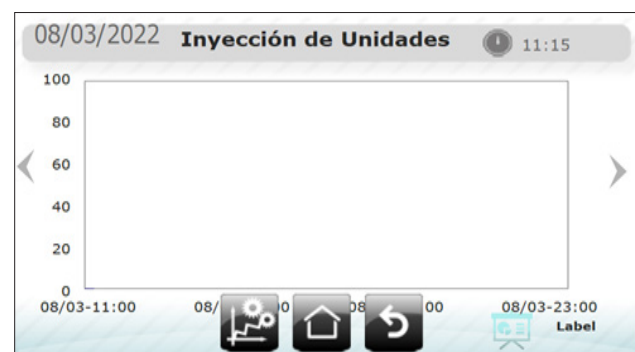

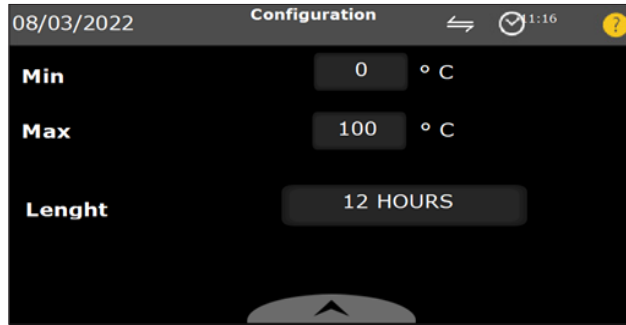

These screens show the actual inputs for each controller.



ALARMS PAGE

When the alarms button is clicked, the user will be presented with a page showing whether or not alarms are present.

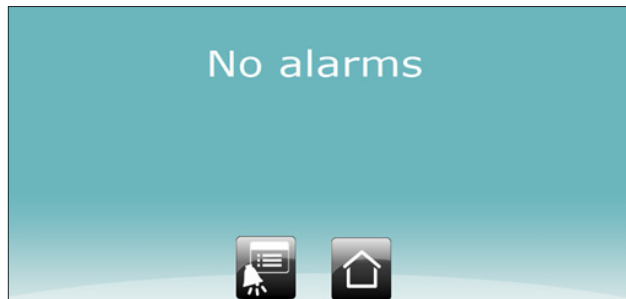

Pressing the active alarms button will display the alarm log.

In this screen you can set the time and date of log alarms or diagnostic information.

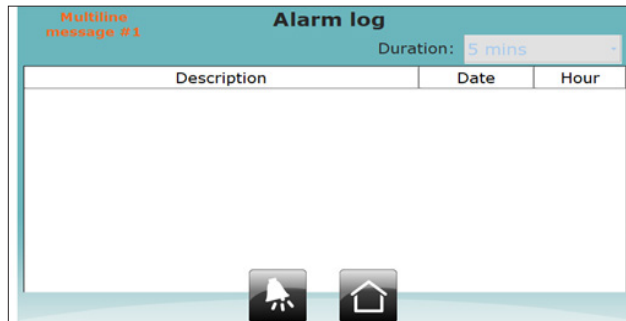

This screen shows the records of the alarms occurring in the short period of time of each alarm.

This screen can check the counter of each high pressure failure, low pressure failure, and the working hours of each compressor.

This screen shows the current working equipment HEATING/COOLING PUMP.

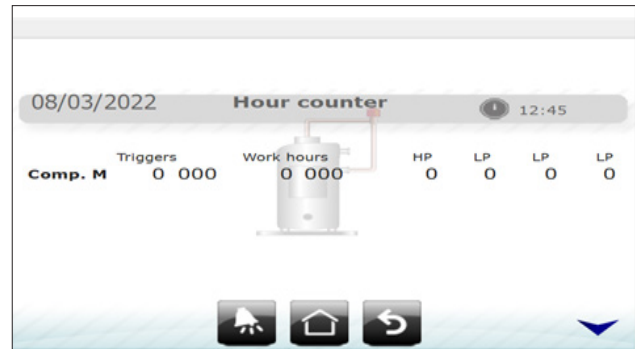

CONTROLLER USE

In this screen you can modify the setpoint temperature of the equipment.

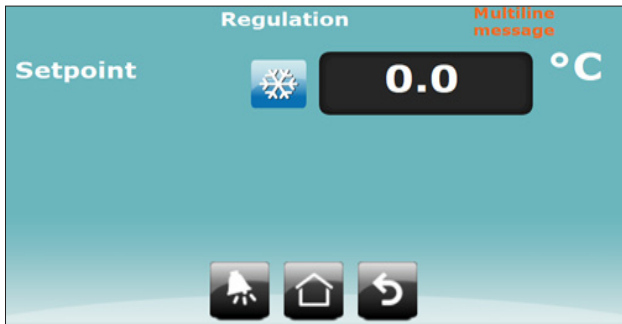

In this screen you can change the language.



EXPORT REGISTRATION

The user can export to a USB memory stick all the information stored in the unit as a csv file (comma separated values file), the user can extract: Registro de alarmas.

- Injection and return temperatures of the master unit.
- Injection and return temperatures of the slaves.
- User registration.

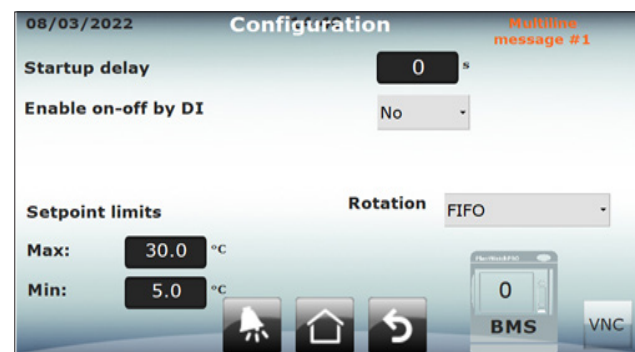
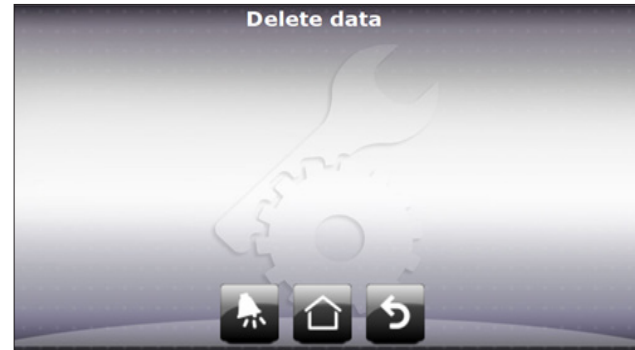

If the user presses the reset button it will be possible to reconfigure the system as a new installation. The reset resets the initial configuration parameters of the system, but does not modify any of the values stored in the controller's memory.



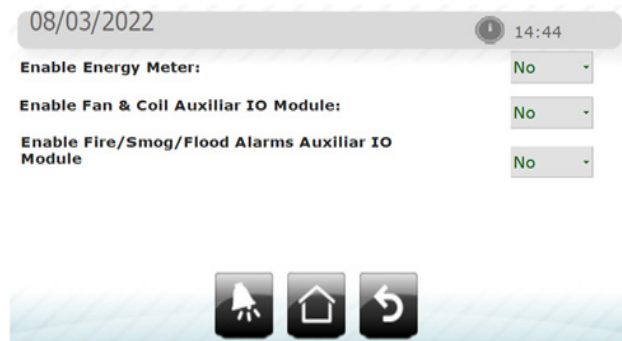
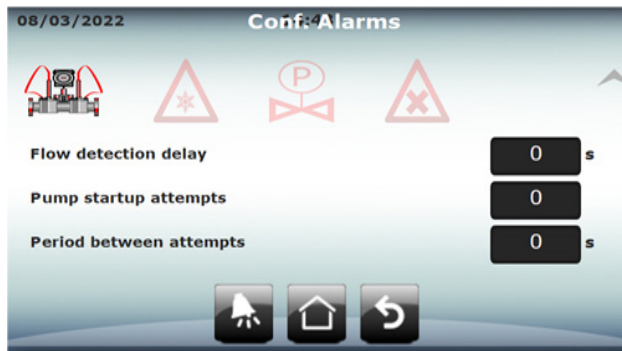
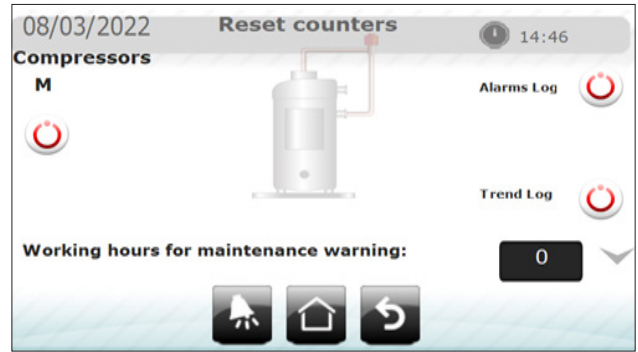
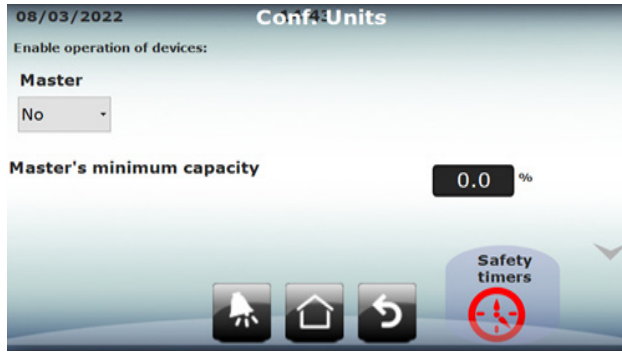

CONTROL PANEL

The following instructions apply to the graphical LCP (LCP 102):
The control panel is divided into four functional groups:

1. Graphical display with status lines. All data is displayed on a graphical LCP display, which can show up to five items of operating data while displaying the [Status].
2. Menu keys and indicator lights - change parameters and switch between display functions.
3. Navigation keys and indicator lights (LEDs).
4. Operation keys and indicator lights (LEDs).

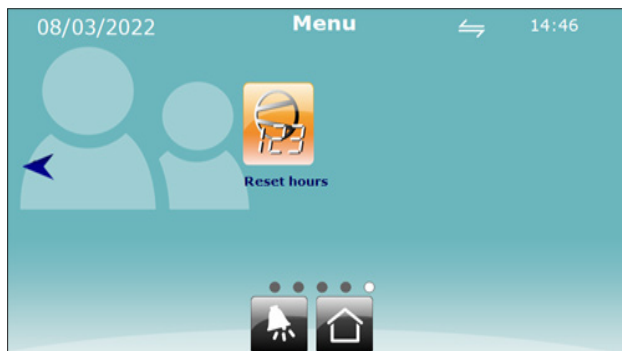

DISPLAY LINES

- A. Status line:** Status messages showing icons and graphic.
- B. Line 1-2:** Operator data lines showing user-defined or user-selected data. By pressing the [Status] key, up to one additional line can be added.
- C. Status line:** Status messages displaying text.

ADJUSTING THE DISPLAY CONTRAST

Press [Status] and [▼] to make the display darker.
Press [Status] and [▲] to make the display brighter.

VDF COMPRESSOR CONTROLLER

Figure 37. LCP Overview

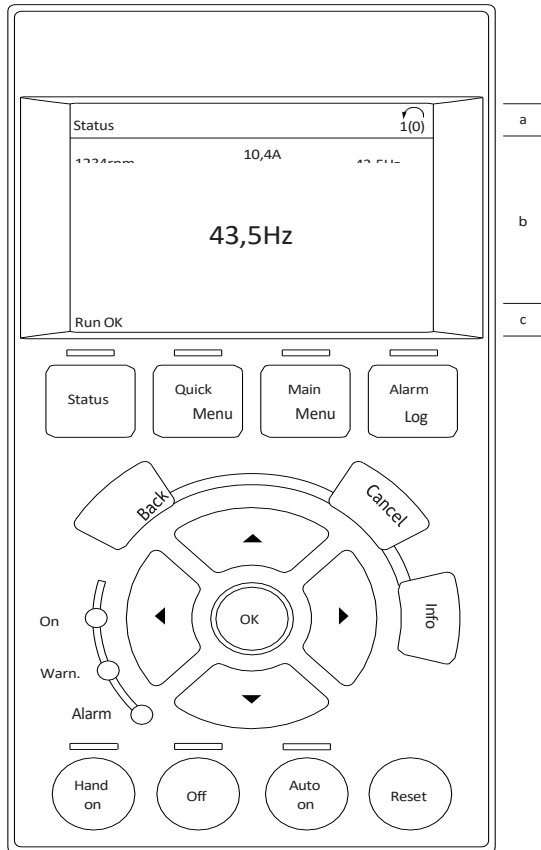

INDICATOR LIGHTS

If certain threshold values are exceeded, the alarm LED lights up and/or the alarm LED lights up. An alarm status and alarm text are displayed on the control panel.

The control panel. The power LED is activated when the frequency inverter is supplied with mains voltage.

- Green LED/on: The control section is running.
- Yellow LED/Warning: Indicates a warning.
- Red LED flashing/Alarm: Indicates an alarm.

Figure 38. Indicator lights

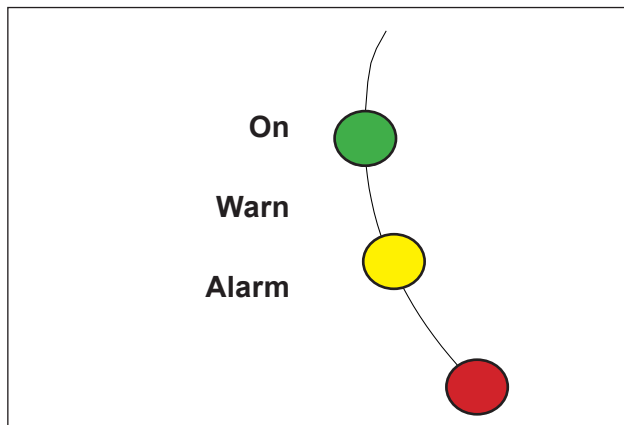

LCP KEYS

The control keys are divided into functions. The keys below the display and the indicator lights are used for parameter settings, including the choice of display indication during normal operation.

Figure 39. Function keys

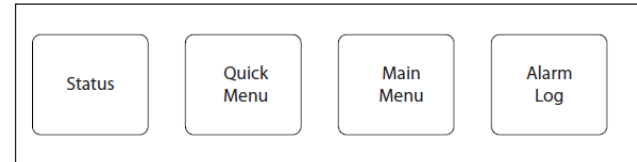

The [Status] indicates the status of the frequency converter and/or compressor motor.

Choose between 3 different readouts by pressing the [Status] key: 5-line readout, 4-line readout or Smart Logic Control by pressing [Status] twice.

Press [Status] to select the display mode or to return to the display mode from the quick menu mode, main menu mode or alarm mode. Also press [Status] to toggle single or dual readout mode.

The [Quick Menu] allows quick access to different quick menus such as:

- Q1 - My personal menu
- Q2 - Quick Setup
- Q3 - PID Process Loop
- Q4 - Compressor functions
- Q5 - Changes made
- Q6 - Logs
- Q7 - Load profile

Use [Quick Menu] to program the parameters belonging to the Quick Menu. It is possible to switch directly between the Quick Menu mode and the Main Menu mode.

NAVIGATION KEYS

The 4 navigation keys are used to navigate between the different options available in [Quick Menu], [Main Menu] and [Alarm Log]. Press the keys to move the cursor.

The [OK] key is used to select a parameter marked by the cursor and to enable changing a parameter and logs from the Quick Menu.

Local control keys

The keys for local control are located at the bottom of the control panel.

Figure 40. Local control keys

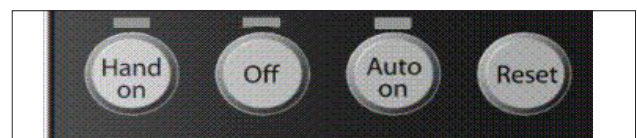

The [Hand On] option allows the frequency converter to be controlled by the LCP. The [Hand on] option also starts the motor compressor and it is possible to enter the speed data of the motor compressor using the arrow keys.

The key can be selected as [1]

Activate or [0] Deactivate via the [Hand on] key 0-40 on the LCP. External stop signals activated via control signals or a serial bus will override a "start" command via the LCP.

The following control signals will remain active when.

[Hand on] is activated:

- [Hand On] - [Off] - [Auto On].
- Reset
- Reverse coasting stop
- Reverse
- Select lsb (least significant bit) - [Hand On] - [Off] - [Auto On]
- msb (most significant bit) select msb (most significant bit) select msb (most significant bit)
- Stop command from serial communication
- Fast stop
- DC brake

The [Off] key stops the connected motor compressor. The key can be selected as [1] Enable or [0] Disable via the 0-41 [Off] key on the LCP. If no external stop function is selected and the [Off] key is inactive, the motor compressor can be stopped by disconnecting the voltage.

[Auto On] allows the frequency converter to be controlled via the control terminals and/or serial communication. When a start signal is applied to the control control terminals and/or the bus, the frequency converter will start. The key can be selected as [1] Enable or [0] Disable via the 0-42 [Auto on] key on the LCP.

NOTES: An active HAND-OFF-AUTO signal via the digital inputs has higher priority than the [Hand on] and [Auto on] control keys.

The [Reset] key is used to reset the frequency converter after an alarm (trip). It can be selected as [1] Enable or [0] Disable using the 0-43 [Reset] key on the LCP.

Direct access to the parameters can be made by holding down the [Main Menu] key for 3 seconds. Parameter shortcut allows direct access to any parameter.

QUICK TRANSFER OF PARAMETER SETTINGS

Once the configuration of a frequency converter has been completed, store the data in the LCP or on a PC via the MCT 10 Set-up Software.

DATA STORAGE IN LCP

1. Go to 0-50 LCP Copy in the main menu.
2. Press [OK].
3. Select [1] All to LCP.
4. Press [OK].
5. All parameter settings are now stored in the LCP indicated by the progress bar. When 100% is reached, press [OK].

NOTES: Stop the motor compressor before performing this operation. The LCP can now be connected to another frequency converter and copy the parameter settings to this frequency converter as well.

INITIALIZATION TO DEFAULT CONFIGURATION

Initialize the frequency converter to default settings in two ways:

A.Recommended initialization (via operating mode 14-22)

- Select operating mode 14-22.
- Press [OK].
- Select [2] Initialization.
- Press [OK].
- Disconnect the mains power and wait until the display turns off.
- Reconnect the mains power.
- A80] (Alarm 80) appears - the frequency converter has been reset.

14-22 Operating mode Initializes everything except:

- 8-30 Protocol
- 8-31 Address
- 8-32 FC port baud rate
- 8-33 Parity / Stop Bits
- 8-34 Estimated cycle time
- 8-35 Minimum Response Delay
- 8-36 Maximum Response Delay
- 8-37 Maximum Inter-Carriage Delay
- 8-38 Maximum Inter-Carriage Delay
- 14-50 RFI filter
- 8-30 Protocol
- 8-31 Address
- 8-32 FC port baud rate
- 8-33 Parity / Stop Bits
- 8-34 Estimated Cycle Time
- 8-35 Minimum Response Delay
- 8-36 Maximum Response Delay
- 8-37 Maximum Inter-Carriage Delay 8-38 Maximum Inter-Carriage Delay
- 14-50 RFI Filter
- 15-00 Operating Hours
- 15-01 Operating Hours
- 15-02 kWh counter
- 15-03 Ignitions
- 15-04 Over temperature
- 15-05 Over voltage
- 15-20 History Log: Event
- 15-21 History Log: Value
- 15-22 History Log: Time
- 15-30 Fault Log: Error Code
- 15-31 Fault Log: Value
- 15-32 Fault log: Time

A.Manual initialization

- Disconnect from the mains and wait until the display turns off.
- Press [Status] - [Main menu] - [OK] at the same time while the LCP 102 graphic is switched on.
- Release the keys after 5 s.

VDF COMPRESSOR CONTROLLER

- The frequency converter is now programmed according to the default settings.

This procedure initializes everything except:

- 15-00 Operating hours
- 15-03 Power On
- 15-04 Over Temperature
- 15-05 Over voltage

DATA TRANSFER FROM THE LCP TO THE FREQUENCY CONVERTER

NOTES: Stop the motor compressor before performing this operation.

1. Go to 0-50 LCP Copy.
2. Press [OK].
3. Select [2] All from LCP.
4. Press [OK] again.
5. The parameter settings stored in the LCP are transferred to the frequency converter indicated by the progress bar. When 100% is reached, press [OK].

PARAMETER SELECTION

In the main menu mode, the parameters are divided into groups. Use the navigation keys to select a parameter group.

Se puede acceder a los siguientes grupos de parámetros:

- - 0-** Operation/Display
- - 1-** Load/Motor
- - 3-** Reference/Ramps
- - 4-** Limits/Warnings
- - 5-** Digital input/output
- - 6-** Analog input/output
- - 7-** Controls
- - 8-** Communication and options
- - 13-** Intelligent logic
- - 14-** Special functions
- - 15-** Drive information
- - 16-** Data readouts
- - 25-** Cascade controller
- - 28-** Compressor functions

After selecting a parameter group, select a parameter with the navigation keys. The middle section of the display shows the number and name of the parameter as well as the value of the selected parameter.

Figure 41. Screen example - Parameter selection

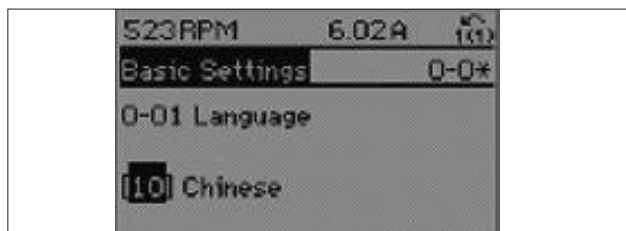

DATA CHANGE

The procedure for changing the data is the same in both the Quick Menu and the Main Menu mode.

Quick menu and in the main menu mode.

Press [OK] to change the selected parameter. The procedure for changing the data depends on whether the selected parameter represents a numerical data value or a text value.

MODIFICATION OF A TEXT VALUE

If the selected parameter is a text value, change the value by pressing the [▲]/[▼] navigation keys. The [▲] key increases the value and [▼] decreases the value. Place the cursor on the value and press the [OK] key to save.

CHANGE A GROUP OF NUMERICAL VALUES

If the selected parameter represents a numerical data value, change it by pressing the navigation keys. Press [◀]/[▶] to move the cursor horizontally. Press the [▲]/[▼] key to change the data value. The [▲] key increases the data value and the [▼] key decreases the data value. Place the cursor on the value and press [OK] to save.

Figure 42. Screen example

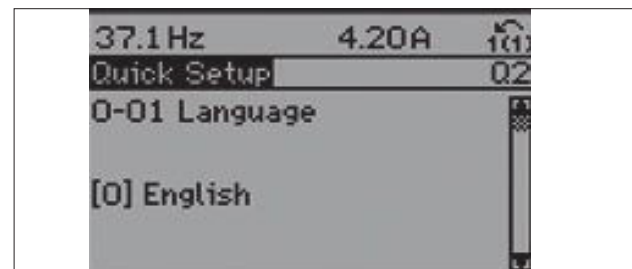

NOTE: The equipment should be energized 24 hours prior to start-up in order to warm up the compressor crankcase before starting the unit. the compressor crankcase before starting the unit.

⚠ WARNING ⚠

If the equipment has not been energized for the indicated time, do not proceed with the start-up as this may cause damage to the equipment.

⚠ WARNING ⚠

The installer must take these procedures into account; his personnel must be qualified and certified to perform the installation in order to comply with all specifications and good practices to ensure proper operation of the unit.

PRE-START-UP CHECKLIST

The following data should be checked before putting the unit into operation.

Date:	
Place of Work:	
Location:	
Installing Contractor:	
Technician/Company:	
Unit Commissioning:	
Unit model:	
Serial number:	

PHYSICAL INSPECTION (BEFORE ELECTRICAL CONNECTION)

Check that the unit has not been damaged by handling or transport.	
Visually check for refrigerant leaks.	
Open the unit for hydraulic installation only. Do not remove the connection guards until the hydraulic circuit is closed.	
Check for foreign objects in the fan discharge.	
Check that the air inlet is not obstructed and has the suggested clearance.	

NOTE: Accessories such as thermometers, pressure gauges, measuring ports, etc., Are recommended but not necessary for the operation of the unit

INSPECTION OF THE HYDRAULIC CIRCUIT

Date:	
Place of Work:	
Location:	
Installing Contractor:	
Technician/Company:	
Unit Commissioning:	
Unit model:	
Serial number:	

It is necessary to install a water filter in all hydraulic circuits to prevent the entry of solid particles, these must be installed on the return side of the circuit and must be cleaned once the initial system load is finished.

Check that the water filter is clean.	
Check that all service valves are open.	
Check the correct structure of the water supply.	
Check that all pipes are filled with water and that air has been evacuated.	
Check thermometers (not included from factory).	
Check the pressure gauges (not included in the delivery).	

⚠ WARNING ⚠

If the hydraulic circuit contains air, it may compromise the operation of the unit.

CHECKING THE ELECTRICAL SUPPLY

The units require grounded, three-phase electrical power.

Verify that the circuit breaker is of the correct rating for the unit.	
Check that all electrical connections are secure.	
Check for false ground contacts as well as all wiring.	
Check internal control and power connections.	
Measure voltage on all units, ground, neutral and 3-phase line.	
Check that the motor overload protection conforms to design requirements and is in automatic mode.	
Check voltage (*Motor save), which is set to supply the correct supply voltage for the unit.	

Note: The control panel of each of the equipment has a duct, placed solely and exclusively for forced ventilation of the equipment. It must not be obstructed for any reason.

STARTUP AND SHUTDOWN PROCEDURES

* The percentage of unbalance of the power supply must be calculated with the following formula, and adjusted with the UNBALANCE command.

$$\text{UNBALANCE PERCENTAGE} = \frac{[(\text{MAXIMUM AVERAGE DEVIATION}) / (\text{AVERAGE})] \times 100}{1}$$



DIAGNOSTIC LIGHT INDICATORS (LED STATUS)

Regular operation	Evergreen
Delayed start	Flashing green
Reverse phase	Flashing red
Phase unbalance	Red in lapses
High/low voltage	Constant red

NOTE: The units are factory set, however the power supply may vary in each installation and due to this imbalance must be adjusted prior to start-up in order to protect the motors and electrical components of all units.

INSPECTION OF THE CONTROL PANEL

Check that the control panel is free of foreign objects.	
Power supply unit with three-phase electrical current.	
The unbalance phase should be less than 2% of the average.	
Turn on each fan to ensure proper rotation.	
Turn on the water pump (if applicable) to make sure it is running.	

⚠ WARNING ⚠

CLIC* units use scroll compressors, which only operate in one direction, disregarding this point, forcing the compressor to operate in the opposite direction can lead to failure.

After completing the inspection of the above installation points and ensuring that all elements of the unit are correct, the unit can be powered up. Turn the switch on the CONTROL UNIT to the ON position to power the control unit with 24 volts.

START-UP

After powering up the controller, wait 5 minutes for the unit to be ready to operate.

The operating sequence will begin by checking all pre-programmed safety points on the unit. If all required conditions are correct, the unit will be ready to start operations.

UNIT CONTROL

To start operations, turn the ON/OFF switch to the ON position. After 6 seconds, the control will command the pump to start. If water flow is detected in the piping, the internal sequence of the unit will start.

NOTE : After completing the inspection of the above installation points and making sure that all elements of the unit are correct, the unit can be turned on. Place the switch on the CONTROL UNIT in the ON position to power the control panel with 24 volts.

ON/OFF

The operating sequence begins with the review of all the pre-programmed safety points in the equipment control, if the necessary conditions are met the equipment is ready to start operation.

To start operation of the unit, turn the ON/OFF switch to the "ON" position.

After 6 seconds the equipment will command the water pump to turn on.

If the unit detects flow in the water pipe, the internal control sequence of this unit will start.

COMPRESSOR

Set switch APG1, 24V to the on position, then set switch APG2, Compressor to the on position and finally set switch APG3, Reset to the on position. switch APG3, This will start the compressors operating cycle.

Note: Switch APG4 selects the operating mode of the machine, cooling only or heat pump.

If you want it to operate in heat pump mode activate the damper.

24V COMPRESSOR RESET



COOLING ONLY
MODE

HEAT-PUMP MODE

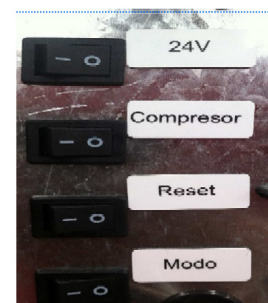

UNIT START-UP RECORD

Date:			
Place of Work:			
Location:			
Unit Model:			
Serial number:			
Compressor Model 1:		Series:	
Compressor Model 2:		Series:	
Compressor Type 1 (x) :		Fixed	Digital
Compressor Type 2 (x):		Fixed	Digital
Pump Model 1:		Series:	
Pump Model 2:		Serie:	
Frequency inverter model:		Series:	
Frequency inverter model:		Series:	
Software version:			
Filter "Yee" (Y/N):	Switch Type	Ultrasonic flow sensor:	Flow switch:
Plate information:		Flow switch type (X):	Amperage:
			R410A load:
Settings	Temperature setting:		Delay:
			Unbalance:

	INITIAL	30 MINUTES	60 MINUTES
Operating capacity			
Water inlet temperature			
Water outlet temperature			
Water inlet pressure			
Water inlet water pressure			
Pump voltage			
Pump amperage			

	CIRCUIT 1 (Master unit)	CIRCUIT 2 (Slave unit 1)	CIRCUIT 3 (Slave unit 2)	CIRCUIT 4 (Slave unit 3)	CIRCUIT 5 (Slave unit 4)	CIRCUIT 6 (Slave unit 5)
Suction pressure						
Discharge pressure						
Saturated suction temperature						
Saturated suction temperature						
Overheating						
Subcooling						

STARTUP AND SHUTDOWN PROCEDURES

		INITIAL					
		CIRCUIT 1 (Master unit)	CIRCUIT 2 (Slave unit 1)	CIRCUIT 3 (Slave unit 2)	CIRCUIT 4 (Slave unit 3)	CIRCUIT 5 (Slave unit 4)	CIRCUIT 6 (Slave unit 5)
COMPRESSOR	VOLT L1-L2						
	VOLT L1-L3						
	VOLT L2-L3						
	AMP L1						
	AMP L2						
	AMP L3						
HOURS OF OPERATION							
COMPRESSOR CYCLE COUNTER START							

OIL LEVEL



FAN MOTOR	VOLT L1-L2						
	VOLT L1-L3						
	VOLT L2-L3						
	AMP L1						
	AMP L2						
	AMP L3						
GENERAL UNIT	VOLT L1-L2						
	VOLT L1-L3						
	VOLT L2-L3						
	AMP L1						
	AMP L2						
	AMP L3						
VOLTAGE UNBALANCE							
AMPERAGE UNBALANCE							

FREQUENCY CONTROLLER CONFIGURATION:

RECOMMENDATIONS / COMMENTS:

CUSTOMER

TECHNICIAN

STARTUP AND SHUTDOWN PROCEDURES

		30 MINUTES					
		CIRCUIT 1 (Master unit)	CIRCUIT 2 (Slave unit 1)	CIRCUIT 3 (Slave unit 2)	CIRCUIT 4 (Slave unit 3)	CIRCUIT 5 (Slave unit 4)	CIRCUIT 6 (Slave unit 5)
COMPRESSOR	VOLT L1-L2						
	VOLT L1-L3						
	VOLT L2-L3						
	AMP L1						
	AMP L2						
	AMP L3						
HOURS OF OPERATION							
COMPRESSOR CYCLE COUNTER START							

OIL LEVEL



FAN MOTOR	VOLT L1-L2						
	VOLT L1-L3						
	VOLT L2-L3						
	AMP L1						
	AMP L2						
	AMP L3						
GENERAL UNIT	VOLT L1-L2						
	VOLT L1-L3						
	VOLT L2-L3						
	AMP L1						
	AMP L2						
	AMP L3						
VOLTAGE UNBALANCE							
AMPERAGE UNBALANCE							

FREQUENCY CONTROLLER CONFIGURATION:

RECOMMENDATIONS / COMMENTS:

CUSTOMER

TECHNICIAN

STARTUP AND SHUTDOWN PROCEDURES

		60 MINUTES					
		CIRCUIT 1 (Master unit)	CIRCUIT 2 (Slave unit 1)	CIRCUIT 3 (Slave unit 2)	CIRCUIT 4 (Slave unit 3)	CIRCUIT 5 (Slave unit 4)	CIRCUIT 6 (Slave unit 5)
COMPRESSOR	VOLT L1-L2						
	VOLT L1-L3						
	VOLT L2-L3						
	AMP L1						
	AMP L2						
	AMP L3						
HOURS OF OPERATION							
COMPRESSOR CYCLE COUNTER START							

OIL LEVEL



FAN MOTOR	VOLT L1-L2						
	VOLT L1-L3						
	VOLT L2-L3						
	AMP L1						
	AMP L2						
	AMP L3						
GENERAL UNIT	VOLT L1-L2						
	VOLT L1-L3						
	VOLT L2-L3						
	AMP L1						
	AMP L2						
	AMP L3						
VOLTAGE UNBALANCE							
AMPERAGE UNBALANCE							

FREQUENCY CONTROLLER CONFIGURATION:

RECOMMENDATIONS / COMMENTS:

CUSTOMER

TECHNICIAN

MAINTENANCE

Service or maintenance of these units should be performed by experienced personnel with specific refrigeration training. Safety devices should be checked repeatedly and cycling control components should be analyzed and corrected before resetting is initiated.

The simplified design of the refrigeration circuit totally eliminates potential problems during regular operation of the unit. No maintenance is required on the refrigeration circuit as long as the unit is operated on a regular basis.

Ease of maintenance has been considered during the design phase; thus, the unit is easily accessible for service and maintenance. By accessing the panel located on the front of the unit, service and maintenance of the unit can be performed easily.

The electrical components are located in the terminal box on the top of the front panel, which allows easy access to them.

Under normal circumstances, this water chiller only requires a check and cleaning of the air inlet through the coil surface. This can be done on a monthly or quarterly basis depending on the environment in which the units are installed.

When the environment is constantly invaded with grease or dust particles, the coils should be cleaned by an air conditioning service technician on a regular basis to ensure adequate cooling capacity and therefore efficient operation of the unit. The regular life span of the unit can be shortened if proper service is not performed.

For consistent durability and performance of the unit, proper maintenance should always be performed on a regular basis.

During extended periods of operation, the heat exchanger will become fouled, impairing the effectiveness and reducing the units performance. Consult your local supplier regarding the cleaning of the heat exchanger.

The internal water circuit does not require major maintenance or service, except for water pump failure. It is recommended that the water filter be checked regularly and replaced if it is dirty or clogged.

Always check the water level in the system to protect the moving components in the hydraulic kit from overheating and excessive wear.

NOTES: The company is not responsible for the malfunction of the unit if the main cause is lack of maintenance or the operating conditions of the unit do not correspond to those recommended in this manual.

GENERAL

Routine checks and maintenance should be performed during initial operation as well as periodically during start-up. These include verification of liquid lines, condensation and suction pressure measurements, as well as checking the unit for normal overheating and undercooling. A maintenance schedule is recommended at the end of this section.

COMPRESSOR MAINTENANCE

The internal pressure and surface temperature of the compressor are DANGERS and can cause permanent injury.

Operators, installers and maintenance personnel require proper skills and tools.

Tube temperatures can exceed 100°C and cause severe burns.

Perform periodic service inspections to ensure system reliability.

To avoid system-related compressor problems, periodic maintenance is recommended:

- Verify that safety devices are operational and properly configured.
- Make sure the system is airtight.
- Verify compressor current consumption.
- Confirm that the system is operating in a consistent manner, check previous maintenance records and environmental conditions.
- Verify that all electrical connections are properly tightened.
- Keep the compressor clean and verify the absence of rust and oxidation on the compressor, frame, tubing and electrical connections.

ELECTRICAL TERMINALS

Electrical connections should be inspected and tightened if necessary. Heat and vibration can cause connections to loosen and fall out, thus causing arc flash stress.

For servicing electrical components:

- Disconnect main power lines before repairing or replacing any components or cables.
- Tighten all wire connections attached to the terminal block and/or components.
- Check connectors, cables and/or components for burn marks, frayed wires, etc. If any of them present these conditions, they should be repaired. or replaced.
- The voltage on the equipment should be checked with a meter periodically to ensure adequate power supply.

NOTES: Each unit comes with complete wiring. Have the diagrams handy when making connections. Electrical connections required at the time of installation are: Power line to power inlet and control wiring for the remote control. Do not wire the remote control with high voltage wires. High voltage may interfere with the control signals and/or may cause erratic or poor operation.

UNIT MAINTENANCE

⚠ WARNING ⚠

Risk of electric shock, can cause injury and death.

Disconnect all power sources before inspecting the fan.

Disconnect all electrical power sources when working inside the unit. Potentially lethal voltages exist within the equipment during operation.

Review all cautions and warnings contained in this manual. Only qualified personnel should service this unit.

CONDENSER

Maintenance consists mainly of removing dirt and debris from the outer surface of the fins and repairing any damage to the fins. For units installed in corrosive environments, cleaning of the fins should be part of the regular maintenance program.

In this type of installation, dust and debris should be removed promptly to avoid build-up that will interfere with the regular operation of the unit.

⚠ WARNING ⚠

Risk of electric shock, may cause injury and death.

Risk of serious injury. Fan may start up and cause injury. Disconnect all power sources before inspecting the fan.

FILTER DRIER

Any particles from the condenser piping, compressor or various components are swept by the refrigerant into the liquid line and trapped by the filter drier.

It is recommended that the filter drier be replaced each time a refrigerant line repair is performed.

EXPANSION VALVE

The function of the expansion valve is to maintain adequate supply of refrigerant to the evaporator. This is in order to satisfy the charge conditions.

Before adjusting the superheat, verify that the unit charge is correct and that the liquid line is completely full and free of bubbles, and that the circuit is operating under stable load conditions. The superheat suction for the evaporator suction discharge is factory set for 10°F.

⚠ WARNING ⚠

Risk of explosive discharge of refrigerant at high pressure. This can cause personal injury or equipment damage. Never loosen refrigerant or electrical line connections until the compressor has been depressurized on both sides.

ANNUAL MAINTENANCE SCHEDULE

Before performing any work on the unit, make sure you have the proper Personal Safety Equipment (EPS), and that the unit is turned off and idle. It is also recommended that the unit be turned on 24 hours prior to first start-up to begin warming up the compressor crankcase.

HYDRAULIC MAINTENANCE

		Jan	Feb	Mar	Apr	May	Jun	Jul	Aug	Sep	Oct	Nov	Dec
Cleaning of the hydronic circuit filter, if present.	Plan	x	x	x	x	x	x	x	x	x	x	x	x
	Real												
Visual inspection of all water pipes for leaks.	Plan	x	x	x	x	x	x	x	x	x	x	x	x
	Real												
Replacing the water in the hydronic circuit.	Plan	x	x	x	x	x	x	x	x	x	x	x	x
	Real												

ELECTRICAL MAINTENANCE													
		Jan	Feb	Mar	Apr	May	Jun	Jul	Aug	Sep	Oct	Nov	Dec
Re-tighten electrical panel connectors and terminals, control parts, power and junction boxes (quarterly)	Plan	x			x			x			x		
	Real												
Physical inspection of all electrical panel connectors and relays (monthly)	Plan	x	x	x	x	x	x	x	x	x	x	x	x
	Real												
Check amperage of all electric motors, compare with equipment nameplate for anomalies (quarterly)	Plan	x			x			x			x		
	Real												
Physically check for false contacts (monthly)	Plan	x	x	x	x	x	x	x	x	x	x	x	x
	Real												
Check the setting and condition of electrical protections and fuses; they must be under the manufacturer's specifications (Twice a month)	Plan	x		x		x		x		x		x	
	Real												
Clean electrical panel (monthly)	Plan	x	x	x	x	x	x	x	x	x	x	x	x
	Real												

PHYSICAL INSPECTION													
		Jan	Feb	Mar	Apr	May	Jun	Jul	Aug	Sep	Oct	Nov	Dec
Cleaning of the condenser with pressurized water (twice a month)	Plan	x		x		x		x		x		x	
	Real												
Refrigerant pressure check (quarterly)	Plan	x			x			x			x		
	Real												
Inspection of fan blades, cleaning of fan blades (Quarterly)	Plan	x			x			x			x		
	Real												
Compressor power consumption check to determine refrigerant loss (quarterly)	Plan	x		x		x		x		x		x	
	Real												
Compressor oil inspection (monthly)	Plan	x	x	x	x	x	x	x	x	x	x	x	x
	Real												
Check and clean the inside of the equipment (Bimonthly)	Plan	x		x		x		x		x		x	
	Real												

TROUBLESHOOTING CHART

Condensate drain line check, must not be clogged (Quarterly)	Plan	x				x				x			
	Real												
Review of alarm history (monthly)	Plan	x	x	x	x	x	x	x	x	x	x	x	x
	Real												

TROUBLESHOOTING CHART

Problem	Possible causes	Possible corrective actions
The compressor does not work.	Main or compressor disconnect switch open.	Circuit breaker closed.
	Fuse damaged, circuit breakers open.	Check the electrical circuit and possible short circuit, line to ground, loss of connections or motor windings causing the failure. Replace the fuse and reset the compressor brakes, only after detecting and correcting the cause of the fault.
	Thermal overloads have tripped.	Overloads are self-resetting. Check supply voltage, operating amps, cycle times and mechanical operations. Allow time for automatic reset.
	Faulty contactor or coil.	Replace.
	System shutdown by equipment protection devices.	Determine the type and cause of the shutdown and correct it before restarting the equipment. For example, low or high pressure, water freezing, etc.
	No cooling required.	Wait until the unit calls for cooling.
	Liquid line solenoid does not open.	Repair or replace the solenoid. Check wiring.
	Motor electrical problems.	Check for open, shorted or bubbled motor.
Compressor makes noise or vibrates	Loose wiring.	Check all wire connections and tighten all terminal screws.
	Compressor running in reverse.	Check that the unit and compressor are on the correct phase of the power line.
	Inadequate piping or supports on suction or discharge.	Reposition, add or remove hangers.
	Worn compressor insulator bushing.	Replace.
	Compressor mechanical failure.	Check for possible problem in compressor failure and replace.
High discharge pressure.	Low oil level.	Check possible problem before it damages the compressor.
	Condenser coil dirty.	Clean the coil.
	Fan does not work.	Check electrical circuit and fan motor.

Problem	Possible causes	Possible corrective actions
	Fan failure.	Check the electrical circuit and possible problems before changing the motor fan.
	Coolant overcharge.	Remove excess coolant and check the liquid subcooling.
	Fan motor running in reverse.	Check that the unit and fan motor are correctly supplanted by the power line.
	No or failed condenser caps.	Check or replace condenser caps on front and rear of unit.
	No condensables in the system.	Remove the non-condensables in the system and replace the charge.
Low suction pressure.	Dirty evaporator.	Backwash or chemical cleaning.
	Lack of refrigerant.	Check for leaks, repair and add necessary charge. Check liquid sight glass.
	Low water flow.	Adjust the water flow required for the equipment.
	Expansion valve malfunction or failure.	Check or replace (if necessary) valve and set proper superheat.
	Solenoid valve not open.	Check circuit and possible problem of solenoid valve not opening, if necessary replace.
	Liquid line filter drier fouled.	Check pressure drop or temperature for diagnostics.
	Condensing temperature too low.	Check means of regulating condenser temperature.
	Excess oil used.	If the system has excess oil, recover and adjust by observing the sight glass on the compressor.
Motor overload relays or circuit breakers open.	Voltage unbalance or out of range.	Correct power supply.
	Faulty or grounded wiring on motor.	Check the electrical circuit for possible problems. Then replace the compressor.
	Loose power wiring or faulty contactors.	Check all connections and tighten them, if necessary replace contactors.
	High condenser temperature.	See corrective steps for high discharge pressure.

TROUBLESHOOTING CHART

Problem	Possible causes	Possible corrective actions
Compressor thermal protection switch open.	Operation beyond design conditions.	Correct to bring conditions within allowable limits.
	Voltage range or unbalance.	Check and correct.
	High superheat.	Set correct superheat.
	Compressor mechanical failure.	Check for possible problem. Then replace the compressor.
	Short cycling.	Check and stabilize load or correct control settings for the application.
Compressor oil level too high or too low.	Low oil level.	Check superheat, if necessary add oil.
	Insufficient water flow - level too high.	Correct the flow, check the superheat.
	Solenoid valve return oil not open.	Check circuit, if necessary replace solenoid valve.
	Short cycling.	Check and stabilize load and correct control settings for the application.
	Excess liquid in crankcase - level too high.	Check crankcase heater. Check operation of liquid line solenoid valve.
	Level too high with compressor operation.	Confirm superheat is correct, remove oil.
	Operation or selection of expansion value.	Confirm superheat at minimum and maximum load conditions.
	Compressor mechanical problems.	Check for possible problem. Then replace compressor.
	Incorrect oil for application.	Check.
	Oil collapse in remote piping.	Check refrigerant piping if correction is necessary.
	Loose fitting in oil line	Repair.
Compressor staging intervals too short.	The control band is not properly adjusted.	Adjust the driver settings for the application.
	Water temperature sensor failure.	Replace.
	Insufficient water flow.	Correct flow.
	Rapid temperature or flow changes.	Stabilize load.
	Oversized equipment.	Evaluate equipment selection.
	Light loads.	Check and adjust load.
The equipment will not work.	Inadequate voltage.	Check the voltage and correct it.
	Reset switch is off.	Switch on.
	No water flow in the system.	Purge the system.
	Water flow is reversed.	Check water direction.

Problem	Possible causes	Possible corrective actions
The equipment works, but does not cool sufficiently.	The set temperature value is an incorrect setting.	Establish values.
	Equipment does not have enough refrigerant.	Check the data sheet and check the system for leaks.
	High condensing temperature.	Check condenser and repair.
	Equipment does not have sufficient water flow.	Check technical data, check filter in water line and adjust flow if necessary.
The fan does not work.	No supply voltage.	Check electrical circuit (line down).
	Motor defective.	Contact the manufacturer.
	Motor thermal protection switch open.	Check operating conditions, if necessary contact the manufacturer.

THIS PAGE IS INTENTIONALLY LEFT BLANK

